

Show Daily



Publisher: Wheel Giant Inc.

October 20, 2016



- 06** City Officials & Bike Industry Enjoy TBW Welcome Party
- 08-25** The Latest Products from Global Suppliers
- 21** TAITRA Announces October Dates for 2018 Taipei Show
- 26** European Bike Market Remains Steadfast
- 30** The Polish Cycle Industry: Developing at a Steady Pace
- 36** A Lackluster 2016 Interbike

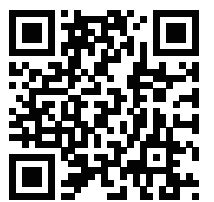

RST

VOLANT AIR

700C
30 mm stanchion
TR:50,60,80mm



E-BIKE



TranzX
inspiring your ride



Remote lever



DROPPER POST

Freely and easily adapting your seat position according to the terrain you meet!

The MICRO adjustment offers quick and easy seat positioning, with reliable and robust technology – virtually No Play!



Remote lever

TODAY

October 20

TAICHUNG

35°C (95°F)

Cloudy



TONIGHT

28°C (82°F)

Cloudy



TOMORROW

32 (90°F)

Cloudy



Thursday, October 20, 2016

Table of Contents

City Officials & Bike Industry Enjoy TBW Welcome Party	6
Sunny Wheel Launches E-Bike Fender Range	8
Cable Integrated Handlebar & Stem from Pro	9
WTB Presents Horizon Road Plus Tire	10
Thun's New BB Sets	10
Ibera's Adjustable Bicycle Hanger	11
Vittoria Announces 2 New Cutting-Edge Tires	12
Prologo Innovations Attract the Best	12
Deda Elementi's Alanera 'Black Wing'	13
Tektro G-Spec Raises the Bar on Brake Performance	13
Selle San Marco New 2018 OEM Range	14
Miche New Road Racing Cassettes	15
Chummy's Rainbow Reflective Decals	15

DOWN TO EARTH



LEV INTEGRA

LEV INTEGRA'S INTERNALLY ROUTED CABLE SIGNIFICANTLY CLEANS UP THE LOOK OF YOUR BIKE WHILE BENEFITTING FROM LEGENDARY LEV TECHNOLOGY. INCREASE THRILLS AND DECREASE DRAG WITH LEV INTEGRA.

KSS

WWW.KSSUSPENSION.COM

COMFORT AERO & STYLE STEERING FOR METREA

AERO DD

TDS-AL-699-8FC V/ISO-M

MATERIAL	FORGED ALLOY
EXT	70 90
RISE	±7°
HEIGHT	40
FINISH	HIGH POLISHED AN COLOR

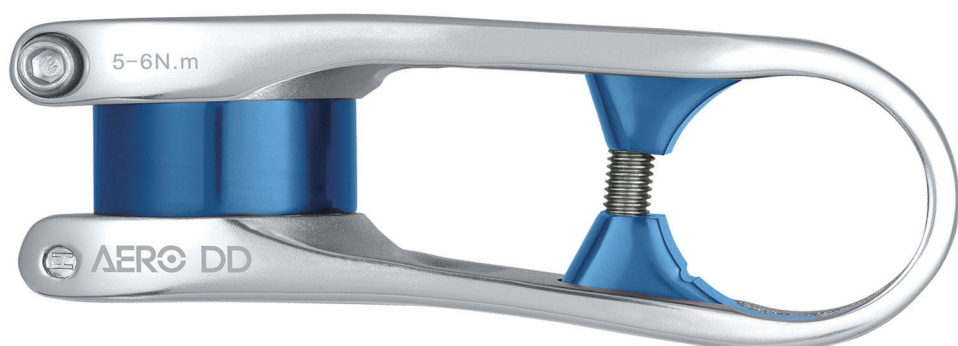

AERO UB

DR-AL-197F0V/ISO

MATERIAL	AL 6061
BAR BORE	Φ31.8
WIDTH	390 410 430 450
WEIGHT	342g(w:430)
FINISH	SAND BLASTED AN COLOR



HL CORP (SHENZHEN)
PRECISION STEERING COMPONENTS
Website: bike.cn.hlcorp.com Email: sales@hlcorp.com

2016.10.18-21

Tempus Hotel Room No.1150-1151

Taiwan's world-class OEM event, exclusively for industry insiders
台湾台中国际自行车展览会



NECO

BOOTH NUMBER 攤位號碼：#1123



NECO 3 行動電源智能碗組
NECO 3 Intelligent Portable Charger

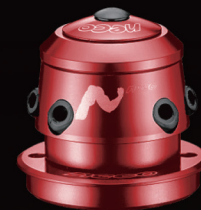

NECO 1 內走線車頭碗組
Intelligent Hidden Wire Headset



NECO 4
智能發電機-不斷電系統
全球專利世界第一自行車發電機 (5v, 2A-10w)
Dynamo Hub Power Generator-UPS System
Global Patent World No.1 Bicycle Generator

Clever's Tire Removal Levers	15
Clarks Hydraulic Disc Brake	16
DKcity's Hot Wheels	16
Alligator Synchronized Caliper	16
Driveline Belt Drive System	16
Tripeak Rear Derailleur Cage	16
First Components Introduce 3 New BBs	18
Shun Shing Crankset	18
Lanxi Wheeltop Present New Cranksets	19
Lanxi Jieke Calipers	19
Trigon Carbon Handlebar	20
GMD's Trendy 25C Tire	20
MDH PXA03 Pedal	20
New Accessories From MHL	20
Integrated Tubeless Tire From Innova	20
Zoom Flanders Series	21
TAITRA Announces October Dates for 2018 Taipei Show	21
New Product Gallery	22
European Bike Market Remains Steadfast	26
The Polish Cycle Industry: Developing at a Steady Pace	30
A Lackluster 2016 Interbike	36

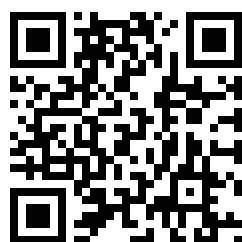

www.taichungbikeweek.com



▲ Front row from left: Kenda Rubber Vice-President Jimmy Yang; Merida President, Michael Tseng; TBW Organizer and Pro-Lite CEO, Steve Fenton; Taichung Deputy Mayor, Chang Kuang-yao; TBA Chairman & Giant CEO, Tony Lo; A-Team Chairman & KMC President, Robert Wu; Ideal President, Hermes Chang. Back row from left: A-Pro Tech CEO George Lee; Ming Cycle President, Chang Tai-Shan; Decathlon Purchasing Director, Didier Morelle; Taichung City Government Deputy Secretary General, Kunming Kuo; Specialized Executive VP, Bob Margevicius; Taichung City Government Economic Development Bureau Director General, Liu Yau-Jr; TBW Co-Organizer & Wheel Giant President Grace S. Ruan; Sram Asia GM, Hank Kao; IDIPC Director, Huang Wong-Hsiu

City Officials & Bike Industry Enjoy TBW Welcome Party

Yesterday evening, October 19, after the second day of the show, TBW organizers and Taichung City Government officials welcomed visitors and exhibitors to Taichung Bike Week at a Welcome Dinner held in the Ocean Hall of the Lin hotel.

The dinner was attended by about 200 people, mostly from the domestic and foreign bicycle industry. Representatives of the Taichung City Government included: Deputy Mayor, Chang Kuang-yao; Economic Development Bureau Director General, Liu Yau-Jr and Deputy Secretary General, Kunming Kuo; IDIPC Director, Huang Wong-Hsiu; and Deputy-Directors, Ho Min-Hao and Wei

Chia-Hung.

At the dinner, Deputy Mayor, Chang Kuang-yao welcomed the bike industry, and thanked them for coming to Taichung. He stressed that bicycles were a very exciting piece of equipment that is constantly evolving and that he hoped that through the efforts of officials and industry, Taichung Bike Week would be held in Taichung every year, as the governments wants to see the deepening development of Taichung's bike industry continue.

Amongst the many bicycle industry VIPs in attendance were TBA Chairman & Giant CEO, Tony Lo; Merida President, Michael Tseng; TBW Organizer

& Pro-Lite CEO, Steve Fenton; Kenda Rubber Vice President, Jimmy Yang; A-Team Chairman & KMC President, Robert Wu; Sram Asia GM, Hank Kao; Ming Cycle President, Chang Tai-Shan; Specialized Executive VP, Bob Margevicius; Joy GM, Jeffery Tsai; FSA Managing Director, Lance Bohlen; Ideal President, Hermes Chang; Wheel Giant, President Grace S. Ruan; Decathlon Purchasing Director, Didier Morelle; A-Pro Tech CEO George Lee; Colmax President, Erik Kimble; Cheng Shin Senior Manager, George Mao;

Tony Lo made a short speech in which he commented on the challenging year that the bike industry is facing and noted

that he was not optimistic for next year. However, he believed that by constantly striving to innovate more opportunities can be created.

TBW Organizer, Steven Fenton also spoke briefly, praising TBW as being a show "by the industry, for the industry." He also spoke of the pride he felt to be a part of the exhibition, and stressed that the industry continues to "look and learn", in an effort to make the bicycle industry more responsive to consumer needs.

The dinner event gave everyone a chance to network with others both within and outside the bike industry, and was enjoyed by all.



▲ Taichung Deputy Mayor, Chang Kuang-yao stated that the City Government will provide full support to TBW and hopes that every year TBW will be held in Taichung.



▲ TBW Organizer & Pro-Lite CEO, Steve Fenton stressed that TBW provides a great business environment.



▲ TBA Chairman & Giant CEO, Tony Lo noted that even though the market was in recession in recent years, the industry was still striving in innovation and R&D in pursuit of progress.



▲ From left: Lee Chi Assistant to President, Sam Lin; IDIPC Deputy-Director, Ho Min-Hao; Kenda, Chang Hong De; Joy GM, Jeffery Tsai; Taichung Deputy Mayor, Chang Kuang-yao; TBW Organizer & Pro-Lite CEO, Steve Fenton; Cheng Shin Senior Manager, George Mao; FSA Managing Director, Lance Bohlen; Colmax President, Erik Kimble, A-Pro Tech Manger Ivan Lin.



▲ From left: TBW Organizer & Pro-Lite CEO, Steve Fenton; Taichung Deputy Mayor, Chang Kuang-yao and TBA Chairman & Giant CEO, Tony Lo welcomed visitors to the Dinner party.



▲ The visitors enjoyed an excellent saxophone performance.



Sunny Wheel Launches E-Bike Fender Range

Sunny Wheel has consistently devoted great effort to R&D in its pursuit of innovation, and has introduced various kinds of e-bike fenders. These fenders enable the easy installation of e-bike motor wiring, and give e-bikes a more streamlined and fashionable appearance.

801E+807B e-bike mudguards.

The special patented trough design allows for the installation of wiring in accordance with design needs, and the patented SW-807B wiring trough panel can be chosen for larger wires (like Bosch's wires) with diameters of up to 10 mm. Customers can also install several wiring trough panels when needed. Mudguards with a wiring trough design are currently available in aluminum and plastic materials.



Mudguards for use with e-bike carriers

These mudguards take adjustment of wires as a starting point of their design, and are attached directly to the carrier. This reduces the need for mudguard supports without affecting the strength of the connection, while also allowing a carrier with a much cleaner lateral design. As a result, the e-bike's appearance is less complicated, and the mudguards can have four built-in wire holes and two cable tunnels.



Mudguards for fat-tire bikes

As fat-tire bikes gradually grow in popularity, Sunny Wheel has also introduced wide plastic fenders—SW-FE-119. The fenders have a width of 122 mm and a customizable length. They are available for both front and rear wheels.



Basket quick releases for use on e-bikes

Because of the control panel, ordinary CTB basket quick release systems cannot be used on e-bikes. Because of this, Sunny Wheel has developed a series of basket quick releases for use on e-bikes. The largest distance between the two locking elements is as much as 120 mm, which ensures that the quick release seat will not interfere with the control panel, and the handlebars will have a better visual effect.  WG



Cable Integrated Handlebar & Stem from Pro

One of the latest projects to come from Pro's close relationship with some of the world's top cycling teams is the opportunity for creativity. Pro's 2017 Vibe handlebar and stem were developed in partnership with Team Sky for the express purpose of minimizing airflow disruption, and providing a cleaner, sleeker cockpit.

The aero handlebars and stems are built around aerofoil shapes and feature smartly positioned cable ports to feed in Shimano Di2 wires or mechanical cables, with the

possibility to go via the stem towards a Shimano Di2 battery positioned inside the fork steerer.

The alloy stem features a low-profile top cap, narrow frontal profile and a unique locking mechanism with reverse titanium bolts for a clean look and reduced air turbulence, resulting in improved aerodynamics.

Meanwhile the carbon Vibe handlebar features Innegra, a material which helps to control and limit the damage that can come from a crash or an impact.

The handlebars are



also compatible with the new Shimano DuraAce 9100 Di2 junction boxes, which can sit at the end of the either drop in place of a bar plug.

Weighing just 220g for the

carbon version, Vibe handlebars are available in carbon or alloy, and in anatomic or compact shapes. Vibe stems are available in alloy only. **WIG**

Pursue limit, quality assurance

STARS Circle

- 展會地點: 台中-金典酒店 (The Splendor Hotel Taichung)
- 攤位號碼: 1048, 10F-A

STARS Circle

JINHUA STARS ALLOY RIMS CO.,LTD

ADD: Hanxiang Jindong Jinhua Zhejiang China TEL: 0086-579-82863555 82862899 82862679
 FAX: 0086-579-82863908 P.C: 321032 E-mail: stars@stars-rim.com

www.stars-rim.com

NUTT JAK

To be with you all the way.
 WE HAVE BETTER DISC BRAKES

2016 台中金典酒店
 The Splendor Hotel Taichung
 booth no. 1212

EL-21SB **JAK-8**

T-1 **ER-1**

S-5 **B-1**

兰溪市捷克运动器材制造有限公司
 LANXI JIEKE SPORTS APPARATUS MANUFACTURING CO.,LTD

地址: 浙江省兰溪市凯旋路123号 Address: NO.123, Kaixuan Road, Lanxi, Zhejiang, China
 邮编/Zip: 321100 电话/Tel: +86 579 88948973 88988019 传真/Fax: +86 579 88988075
 Http://www.discbrake.cn E-MAIL: chinayake@126.com

WTB Presents Horizon Road Plus Tire

Recent years have seen two trends becoming popular in road bikes: Firstly, tires with larger air volumes and secondly, bikes designed for adventure / gravel use. WTB can be relied upon to come out with stylish products that not only fit in with market trends, but also to set them.

At this year's Taichung Bike Week, WTB are once more generating much attention with one of its newest tires—the Horizon Road Plus. Aimed at adventure / gravel / bikepacking / touring bikes, the Horizon Road Plus is a tubeless 650 x 47C tire. The tire's larger volume helps drown out road noise, jarring gravel and the irregularities of dirt. With the overall diameter of the 650 x 47C Horizon Road Plus being the same as a 700 x

30C tire, large volume benefits are gained while working with the same geometry used by current endurance road bike designs.

Combining the efficiency of a slick centerline with the all-weather grip of a herringbone pattern on the side makes the Horizon Road Plus a tire that can get up to speed easily while still offering extra grip in inclement weather. The supple compliance of TCS tubeless provides the traction needed to keep this retro-esque tire grabbing hold of anything the rider leans them through.

WTB is introducing the Horizon Road Plus and other products in their range to global product managers in the Harvard room on the 3rd floor of the Tempus Hotel. 



▲ WTB's Will Ritchie presented the Horizon Road Plus.

Thun's New BB Sets

Thun offers a large variety of bottom bracket (BB) sets, of which two are particularly suited for Asian bicycle and e-bike manufacturers. The Paso BB can be installed on city, trekking and mountain bikes. Its spindle is zinc plated and it features long-lasting and sealed ball bearings that are well protected, situated underneath a sleeve, and threaded cups reinforced with an ultra-durable polyamide.

The X-Cell RT BB features a highly advanced sensor technology enabling measurement of rotation, rotational direction and torque. This allows front and rear drive systems to provide the smoothest e-bike experience.

Within the next few months, Thun will further strengthen its presence in the Far East through measures that allow enhanced proximity to respective markets. Catherine Hsu is Thun's agent in the region, and she is happy to answer any inquiry at their booth in the Evergreen Hotel. 

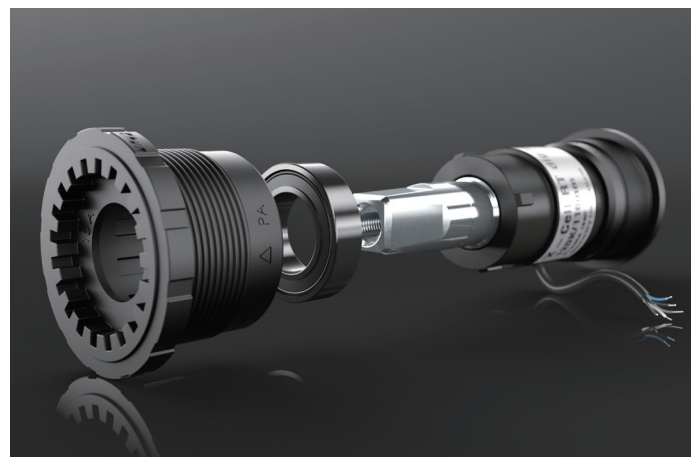

GT MARK

The Splendor Hotel 1047
Tempus Hotel 2F LeBar2-3



580QR

AFA RC53

E-mail: lizhi185cz@163.com

Shenzhen Lizhixin Science and Technology co.,ltd

Ibera's Adjustable Bicycle Hanger

Known mainly for its award-winning pannier and carrier bag systems, Ibera, one of Taiwan's leading accessory manufacturers, is expanding its product offerings further with a wall-mounted bicycle hanger.

Ibera products are renowned for combining function with style, and its new bike hanger is no exception to this. The space-saving Ibera bicycle wall hanger (Model: IB-ST4) is one of the most versatile on the market. It is perfect for storing, displaying, or working on a bike. It features a two-way adjustment

system, with the hanger beam length adjustable to fit narrow or wide handlebars, and frame holders that are angle-adjustable to keep wheels horizontal. Helmets or other bike gear can also be hung on the hanger.

The sturdy design, crafted from aluminum and steel, features padded ABS frame holders that won't scratch bike frames. Ibera is introducing their full range of products in booths 6 & 7 of Hall A in the Tempus Hotel. 







Taiwan Bicycle Source

TBS is a dedicated and experienced service of Wheel Giant, which has the confidence of Taiwan's bike manufacturers, and is essential to the future of Taiwan's bike industry.



Access a market of giant proportions with TBS!
The ultimate purchaser's guide to Taiwanese firms, this 5-in-1 tool is available in full-size volume, pocket issue, CD-ROM, downloadable e-book and online.







TBS e-book DVD



Hyper Database



I Pad / I phone App



Pocket Issue

http://www.biketaiwan.com/



輪彥國際有限公司
WHEEL GIANT INC.

No. 193, Tzu-Chiang Rd., Changhua 50095, Changhua, Taiwan
Tel: 886-4-7350500, 7360794-5 Fax: 886-4-7357860, 7360789
E-mail: tbs@mail.wheelgiant.com.tw Website: www.biketaiwan.com

軟實力傳媒有限公司
Soft Power Media Co., Ltd.

Shanghai Tel: 86-512-57515789 Tianjin Tel: 86-22-28137963
Ningbo Tel: 86-574-88210669 Shenzhen Tel: 86-755-81789589



DNM
performance suspension

USD-8

- RIDING STYLE: DH/FR
- AXLE: 20MM



RC-15

- RIDING STYLE: XC/TRAIL/AM
- AXLE: 15MM



HQS

- WEIGHT: 30.9
- 31.6
- 34.9 MM



AO-42RC

- RIDING STYLE: AM/XC/TRAIL



dnmstock.com

Vittoria Announces 2 New Cutting-Edge Tires

Vittoria has announced several developments in tire design, with the Terreno Dry tire being the main news for MY2018. This tire bridges the gap between file treads and all-conditions treads, and is available in tubular or TNT casing. The center 'scales' are ramped, providing a fast rolling leading edge, yet sharp, effective braking and cornering edges for this semi-knob Cyclocross and Gravel race tire. The progressive depth tread design allows for a smoother transition between cornering lean angles. It has been developed with 3C technology and Vittoria's G+Isotech compound. The tire is available in ranges of 31-28" (450g), 700x31C (415g), 33-28" (460g), 700x33C (425g), and 700x38C (440g).

In addition, Vittoria has developed the MY-18 Barzo tire,

a medium depth moto-block pattern for technical XC terrain. It features a defined alternating central ridge which makes this tire self-cleaning. The Barzo is available in rigid, foldable or TNT casing, and has been enhanced with 4C technology and the G+Isotech compound.

Vittoria 3C and 4C stands for a layering process, using separate compounds in a single tire tread. The 4C process offers unmatched versatility, by allowing for separate base and surface compounds in both the center and side areas of the tread. G+Isotech® is Vittoria's unique Graphene compound, with the revolutionary G+, as provided by technology partner Directa Plus. This compound is superior in terms of rolling resistance speed, grip, durability and wear resistance. 



Prologo Innovations Attract the Best

Prologo's entire product range doesn't just look beautiful, it is packed full of innovations to improve cycling performance, comfort and efficiency. One of the renowned saddle manufacturer's latest range of saddles is the Scratch 2, which happens to be the saddle of choice for Peter Sagan. Featuring Prologo's patented Connect Power Control (CPC) layer of micro hexagonal cylinders, made from a special nano-technology polymer, this layer, which rises millimeters above the saddle

covering, improves ride comfort by cushioning vibrations and improves grip in all weather conditions, allowing riders to more easily maintain a perfect and stable sitting position, while also aiding cooling by allowing

air to circulate between the rider's body and the saddle. The Scratch 2 has a carbon base with TiroX rails. It is available in saddle shapes suitable for road bikes, off-road bikes and unisex bikes. 



▲ Prologo Brand Manager, Salvatore Truglio holds a Peter Sagan Edition saddle.

Deda Elementi's Alanera 'Black Wing'



Deda Elementi is once again this year presenting its stunning line-up of race-winning components in the Tempus Hotel. Highlights from this year's range include the Alanera integrated carbon fiber handlebar and stem set. The word Alanera means

'black wing', and it is easy to see how this aerodynamic set gets the name with its beautiful aesthetics. However, the Alanera also offers riders significant technical advantages; the shallow depth of the aero bar also gives riders extra clearance on top. The internal cable routing is compatible with Shimano's

next generation Di2 system, with the control unit in the handlebar. The Alanera drops also feature Deda Elementi's Rapid Hand Movement RHM technology, allowing riders to quickly and efficiently get down onto the drops. An adapter can also be integrated to allow for a rider to mount Garmin 500

and 800 series display units, and aerodynamic covers are available for both the adapter mounting point when not in use and the headset cover. The Alanera is available with a drop distance from 90 to 130 mm and in widths of 420, 440 and 460 mm. **WG**

Tektro G-Spec Raises the Bar on Brake Performance

The R&D department at Tektro and TRP have been busy over the last year. Among the many new braking products developed is an entire new line of cutting-edge systems, named G-Spec. This line has been developed in close cooperation with four-time UCI Downhill World Champion, Aaron Gwin, who acted almost as chief engineer to the Tektro R&D team.

The jewel in the crown of the G-Spec level is the Quadiem hydraulic disc brake. Together with Tektro engineers, Aaron Gwin worked relentlessly to perfect the Quadiem; constantly refining the design until it was exactly what the World Champion wanted – the lever blade alone went through six iterations until it was considered perfect for him. As the name of the brake

implies, the Quadiem is a four piston design that uses mineral oil in an open reservoir system. The caliper features special cooling fins to improve heat dissipation from the powerful yet supremely responsive brake. During development no details were overlooked: New pad compounds were developed offering stopping power just in the 'Goldilocks zone' of performance between power and response. Shallow grooves were even laser-etched onto the rotor surface to enhance heat dissipation. The end result of all these improvements is, in the words of the TRP Managing Director, Lance Larrabee "the best brake we've ever produced."

MY2018 Tektro and TRP products are being introduced to customers at TBW on the 15th floor of the Splendor Hotel. **WG**



▲ TRP Managing Director, Lance Larrabee introduced G-Spec Quadiem.

Selle San Marco New 2018 OEM Range

Selle San Marco is unveiling their new 2018 OEM range at Taichung Bike Week.

The Italian brand - high-end saddle makers since 1935 – are still offering the exclusive tool, CMC (Custom Matching Color). CMC is an innovative software program that lets customers choose and personalize all of their products in every single detail, and lets them see the outcome immediately. Customers can use their imagination to mix colors for their forthcoming range of products, and those choices can

be reproduced on the screen, for a perfect mix between frame and components. The customization software provides endless options for riders, using only a few, simple steps.

The Mantra, which is now available in the Dynamic level, is new, with a manganese rail at a more affordable cost. A clear and simple design, it shares a family feeling with Selle San Marco's higher range saddles, but with fewer elaborate features.

Off-road the research of the best performances have lead Selle San Marco to introduce

a new padding for their Dirty models, that will be equipped with Biofoam Plus. This material assures a decreased weight, while providing better shock absorption, thanks to the special structure of the padding.

Selle San Marco is also announcing news of their Bottega products. This line, motivated by all that has been thus far achieved from years of experience in the bicycle world, has inspired a selected number of evergreen saddles, such as the Concor (Light, Supercorsa,

Profil), that joins the existing models Regal, Regal EVO and Rolls. A taste of retro meets modern design, for use in the ever - changing life of cycling, while maintaining the importance of essential details. This year, riders can choose from a full selection of Selle San Marco icons that embody the history of cycling. 



**Come to us with your ideas,
we'll make them a reality.**

OEM Manufacturing

- Frames
- Forks
- Wheels
- Carbon Products



www.pro-lite.net

Booth B5
Evergreen Hotel



PRO-LITE

Miche New Road Racing Cassettes

With the Primato, Miche have developed an extremely flexible cassette, with a wide range of ratios, Miche's road racing cassettes are perfectly compatible with all the shifting systems in the market. 11, 10 and also 9 speeds are available, with the possibility for customization of ratios.

All of the sprockets and

cassettes are produced in Italy, and are made of chrome-plated steel, CNC machined for a perfect match with the freewheel body's splines, and also rear derailleurs indexing.

Light Primato 11S. range is made with 10 chrome-plated steel sprockets and the last sprocket made of AL7075-T6. 



Clever's Tire Removal Levers

The ingenious blade design of Clever's steel tire removal levers not only look very special, they also have an additional function. When joined together, the blades can be used as a chain-splitting tool. Additionally, the middle portion of the levers has been left empty to allow for the printing of customer logos. 



Chummy's Rainbow Reflective Decals

As long as this decal is exposed to light, the reflective surface of Chummy's new decals will have a colorful reflective effect quite different from other decals on the market. The color changes when viewed from different angles, making the decal suitable to be used on different color backgrounds. These patent-pending Rainbow Reflective Decals are suitable for use on a wide variety of products including frames, helmets and wheels. The decals also have the additional benefit of increasing safety while riding at night. 



DEUTER
BICYCLE WHEELS

STORM
2017 NEW PRODUCTS





SHENZHEN DEUTER BICYCLE CO., LTD.
TEL: +86755-27412401 FAX: +86755-23403567
Email: gq|xqh@163.com Mobile: 13088882101



PROFESSIONAL RIBBER CENTER

All use full carbon tubeless ready rim

COM SPORTS(HONGKONG) CO., LIMITED
Email: anna-comsports@hotmail.com
Skype: anna_xds

Clarks Hydraulic Disc Brake



Headquartered in the UK, Clarks has production facilities in both Taiwan and China. This year the British company has launched the M2 hydraulic disc brake with an emphasis on both price and functionality advantages. Using more environmentally-friendly mineral oil, the M2 disc brake system has won praise from numerous bicycle magazine evaluations, and has also passed IS 4210 certification. Suitable for use on road, MTB and city bikes, the brake has rotor options of 140, 160 and 180 mm. 

DKcity's Hot Wheels

DKcity is presenting its Hot Wheels e-bike conversion kit, comprising of a motor, control unit, and battery all contained within a front wheel — a Hot Wheel. By also additionally installing a sensor in the crank, the kit allows any bike to be converted into an e-bike. DKcity has also developed a dedicated app which can be used to adjust power modes and see speed, mileage power and other information. Hot Wheels are available in sizes of 20", 26" and 28", and one battery charge will last for approximately 50km of riding. 



Alligator Synchronized Caliper

Alligator's new road bike dual-pivot caliper brake improves the structure of the caliper by means of a new lever, which allows the force applied by users when braking to be applied to both arms of the caliper in unison. In this way both arms move in synchronization, allowing for more stable and more responsive braking. 

Driveline Belt Drive System

Driveline, a traditional manufacturer of belt systems for many years, often encountered a situation in which after a customer had bought a system, then found that the frame drop outs were incompatible. In order to make customer assembly

more convenient, Driveline has launched a more complete belt drive system which includes a belt, crankset, flywheel and specialized dropout. The new system supports an Alfine 11 internal gear hub and disc brakes. 



Tripeak Rear Derailleur Cage

In order to make the action of the chain in the rear transmission system more fluid, with reduced resistance, increasing the guide wheel size has become a trend. Tripeak has introduced a variety of specifications of derailleur cages, compatible with Shimano or SRAM systems, with options

of 11 / 15T or 15 / 15T on the pulley wheels. Consumers only need to purchase the correct specification derailleur cage to be able to install the oversized cage by themselves. Tripeak oversized derailleur cages weigh in at 64 grams for an aluminum version and 54 grams for a carbon fiber version. 





THE MPX-11 BREAKS NEW GROUND IN COMPETITION LEVEL CRANKS FOR ENDURO RIDING SPECIFICALLY DESIGNED FOR OFFROAD 1X SYSTEMS, MPX-11 WILL POWER YOU TO OVERCOME ALL OBSTACLES.

- * 1X SPECIFIC TOOTH PROFILE SECURELY HOLDS THE CHAIN WITHOUT THE NEED FOR CHAINGUARD
- * NEW COLD FORGED SHAPE MAXIMIZES STRENGTH WHILE KEEPING WEIGHT DOWN
- * COORDINATED ANODIZED COLOR ACCENTS

MPX11-36T-TT

CRANK LENGTH 170MM,175MM
 CRANK MATERIAL FORGED AL-6061-T6
 CRANK FINISH BLACK SAND ANO.

CHAINRING .38T,36T,34T,32T,30T,28T
 CHAINRING MATERIAL AL-7075-T6
 CHAINRING FINISH BLACK SAND ANO.

COMPATIBILITY 11S
 CHAINLINE 49MM
 Q - I FACTOR 171/141MM



PW-BB73+



PW-BB92

浩盟企業股份有限公司
 WHOLE MAN ENTERPRISE (TAIWAN) CO.,LTD
 地址: 70460臺南市北區北成路47號
 NO.47 BEICHENG ROAD, NORTH DISTRICT,
 TAINAN, TAIWAN,70460
 TEL: 886-6-2825791/92
 FAX: 886-6-2825746
 E-MAIL: PROWHEEL@MS13.HINET.NET
 SALES-TW@PRO-WHEEL.COM

浩盟車料(上海)有限公司
 HAOMENG BICYCLE (SHANGHAI) CO.,LTD.
 地址: 上海市奉賢區四團鎮川南奉公路8553號
 NO.8553 CHUANNANFENG ROAD, SITUAN TOWN,
 FENGXIAN DISTRICT, SHANGHAI CHINA
 TEL: 86-21-57532846/47
 FAX: 86-21-57536961
 E-MAIL: SALES-TW@PRO-WHEEL.COM

浩盟車料精鍛科技(天津)有限公司
 WHOLE MAN ENTERPRISE (TIANJIN) CO.,LTD
 地址: 天津市經濟開發區西區新南路8號
 NO.8XINMIN ROAD,WEST AREA DEVELOPING ZONE
 TIANJIN CHINA
 TEL: 86-22-66321818
 FAX: 86-22-6321820
 E-MAIL: SALES-TW@PRO-WHEEL.COM

First Components Introduce 3 New BBs

Every exhibition First Components launch new products, and at this year's Taichung Bike Week, the product focus is on bottom brackets, as First Components introduce three new BBs.

G207A Press-Fit BB

When existing press fit BBs are glued into the BB shell, they can often break or damage the frame when they are removed. First Components have launched the G207A—a press fit 46mm BB which can be easily put into the BB housing and secured by 3 bolts which are tightened with a hex key. A special extending structure within the BB then locks the BB in place. To remove the BB, the 3 hex bolts simply need to be unscrewed and the BB can

be removed very easily without any further need of tools, thus avoiding damage to any part.

Angular Contact Thrust Bearing BB

Many standard bearings easily lock in the incorrect position during assembly resulting in impaired flexibility. In order to overcome the drawbacks of these standard bearings, First Components have developed its Angular Contact Thrust Bearing BB which has a special structure that can reduce the gap between the bearing and the spindle helping to prevent noise and loosening. Additionally, the bearings are at a 25 degree angle (standard is 90 degrees) which can help prevent bearing damage when assembled.



▲ First Component's General Manager, Johnson Lee said that with a generally poor market environment, First Components must be more involved in the development of new products.

Thread for Press-Fit BB

Press-fit bottom brackets can easily loosen, especially in carbon fiber frames, by changing to a thread fit type, advantage can be taken of the thread locking force to prevent the BB coming loose due to riding. Both sides of the BB can be screwed in by hand, then locked with special tools.

General Manager Johnson Lee said that with a generally poor market environment, First

Components must be more involved in the development of new products, and continue to make upgrades to existing products, in order to meet customer needs. He also said that when attending the exhibition, customers often ask "What's new?" So there if there are no new products to show, so it is not easy to attract customers. So at the beginning of each year First Components will make a plan to have a new product at every show. 🌟WG



▲ First Components new products. From the right: A new headset cover, the G207A press-fit BB, the Angular Contact Thrust Bearing BB and the Thread for Press-Fit BB.



Shun Shing Crankset

This crankset has been made exclusively for road bikes. The crank itself is carbon fiber, and the chainring comes in two sizes: 50/34T and 53/39T. It can be used with PF and BB386 systems, and it weighs 510g. It has been tested by racers, who report that it is light and smooth when shifting gears. The crankset efficiently transfers pedal power to the chain with little wasted energy. 🌟WG

Lanxi Wheeltop Present New Cranksets

CR11A 1X12

This chainring has both high and low teeth; the higher teeth function to prevent the chain from falling off, while the lower teeth control the chain's lateral movement. The teeth are 3D forged to ensure that each tooth is identical in shape and strength. These teeth are slightly rounded at the top to effortlessly engage the chain, providing a smooth, quiet ride.

The Sage11 chainring is made from a 5 mm alloy, so it is strong enough to fully transfer all of the power coming from the pedals to the chain, maximizing efficiency. The teeth are CNC machined to ensure smooth chain movement when shifting. 



Lanxi Jieke Calipers

Markets are trending towards disc brakes, so Lanxi Jieke is introducing disc brake calipers for road bikes. The integrated caliper body is made from an aluminum alloy, so it is lightweight, 50 grams lighter than Lanxi's previous calipers, and it also looks very sleek. The hybrid design combines mechanical and hydraulic system, which

make it more robust and easy to use. The calipers require no tubing for oil, improving reliability under hot conditions by preventing oil evaporation, and eliminating breakdowns due to oil starvation. Lanxi also provides an lever exclusively for e-bikes, which cuts electrical drive to the wheels under braking. The e-bike lever is completely weather proof, increasing part longevity. 



2016 TAICHUNG BIKE:

SPLENDOR #1050

 定向高低齿

 高强度锻压齿

 低斜度入链齿



LANXI WHEEL TOP CYCLE INDUSTRIES LTD
 Tel: +86(579)89022978
 E-mail: wheeltop@126.com

TIANJIN WHEEL TOP CYCLE INDUSTRIES LTD
 Tel: +86(22)59696335
 E-mail: ELAINE@wheeltop.com

Trigon Carbon Handlebar

The new Trigon Carbon Handlebar allows control cables to be housed inside the body of the handle bar, and is compatible with the Shimano Di2 system. The drops are angled slightly outwards, for greater riding comfort. The handle bar comes in two sizes, with widths of 420 or 440 mm, and weighing in at 210 grams (for the 420 mm model). WG



GMD's Trendy 25C Tire

While most road bikes use 23C tires, 25C tires are becoming more popular recently. GMD is introducing their new 25C road bike tire to meet this growing demand. The G502N is a 700x25C sized tire, designed with a tread that allows for easy and quick rolling. On the sides, the tread is specifically designed to channel water away from the tire for added safety and speed in wet weather. WG



MDH PXA03 Pedal

Mandai's latest big, thin platform pedal has a curved tread area designed to reduce slipping and increase the stability of the pedal. The pedal's variation of thickness increases, giving cyclists a smooth ride. WG

New Accessories From MHL

MHL is introducing many new bike accessories this year at TBW. These include frame bags, saddle bags, handle bar grips, and a cuff strap to prevent rider's pants from becoming entangled in the chain. All of these products are manufactured using environmentally friendly materials, derived from PET recycled plastic bottles, combined with natural leather, which makes them both lighter than traditional leather, and much cheaper. They are water resistant and durable, with a old-time retro look, suitable for city bikes. WG



Integrated Tubeless Tire From Innova

Innova's ITT (Integrated Tubeless Tire) is a clincher tubular tire. The tire has a built-in liner that acts as an inner tube, preventing side leaks. This tire features the reliability of a tubed tire with the ease of use and weight savings of a tubeless tire. It offers superior puncture protection, both from exterior environmental hazards and piercings of the inner tube due to rim/ground impacts. Innova is offering a variety of tread styles for different cycling styles. WG



Zoom Flanders Series

In response to racing bike market demands, Zoom are introducing its latest Flanders Series handlebars. Aimed mainly at endurance and long-distance riding. Paying particular attention to riding comfort and avoiding fatigue.

Flanders handlebars are made from Toray carbon cloth

and feature a larger bar bore for easily equipping meters and accessories, while a back sweep angle on the bars allows for an excellent grip when climbing. The Flanders is designed to be used with Shimano's Di2 system with external routing that is convenient for replacing cables. The Reach has been

shortened to 73 mm to increase rider control and two different drop styles are available in four widths from 380 mm to 440 mm. The 420 mm version weighs in at only 190 grams.

Zooms Flanders Series seat tube has a one-piece molded carbon shaft and head with a precision forged 6066

alloy clamp that utilizes a one-bolt clamping system. The clamp design is interchangeable for standard 7 x 7mm or 7 x 10 mm saddle rails. The Flanders Series seatpost is available in lengths of 270, 320 and 370 mm. WG



TAITRA Announces New October Dates for 2018 Taipei Show

Taiwan External Trade Development Council (TAITRA) President and CEO, Peter Huang and Taiwan Bicycle Association (TBA) Chairman, Tony Lo held a press conference at Lin Hotel at 2:00 PM on October 19. At the press conference it was announced that the 2018 Taipei Cycle Show would be held from October 31st to November 3rd.

Tony Lo explained that while a reason for the change to October was partly so that Taipei Show could regain its status as an OEM ordering show, the main reason was so that the show could be the trendsetter and innovation indicator of the cycling world.

The 2017 Taipei International Cycle Show,

which will be held from March 22 to March 25 at the Taipei World Trade Center Nangang Exhibition Hall.

For the 2017 event, Taipei Cycle Show have a new logo symbolizing the variety that the Show presents, as well as its connection with Taiwan cycling industry. A slogan has also been developed - "A New Worldview on Cycling".

On March 21, one day before the 2017 Taipei show opens, its first-ever Demo Day will be held at a suitable setting nearby the showground, so that buyers and exhibitors will experience the functionalities of bicycles extensively, by test riding on different terrains.

To commemorate 30 years of Taipei Cycle Show, TAITRA

and the TBA will nominate "Taiwan Cycling Person of the Year". Media dedicated to reporting the cycling industry will then select the person to be

accorded with this award. The result will be announced in the opening ceremony of the 2017 Show next March. WG



▲ Taiwan External Trade Development Council (TAITRA) President and CEO, Peter Huang and Taiwan Bicycle Association (TBA) Chairman, Tony Lo announced that 2018 Taipei Cycle Show will be held at the end of October.

New Product Gallery

C.D. Components Co., Ltd.

CD-266

PATENT

C.D. Components CD-266 is a folding rack rear carrier. The patented design features a new type fitting set. The alloy rack is adjustable from 26" to 29", and comes with a powder coating finish in either silver or black.

+886-4-76896586



Velo

VL-6374

Tempus
Holland Room

The ergonomic design of this saddle makes it an excellent choice for e-bikes. The VL3586 is designed with more foam to hold the rider's body in position. In addition, a patented 'Atoms Shaping' surface gives a sleek finish without a visible seam between the cover and a base that is 100% waterproof, easy for cleaning and maintaining after use. The base features an ArcTech suspension system which can provide superior racing support.

To round out the long list of features the saddle also has anti-collision protection and a hidden handle.

+886-4-26864546

www.velosaddles.com



ControlTech

Falcon

The Falcon finishing kit brings integrated aero design to any bicycle. The Falcon road ergo bar is for all road riders. A sleek stem/bar interface reduces drag and simplifies the bike's profile for wind-cheating performance. A complete Falcon gruppo including speed saddle, rear hydration systems, bottle cage and water bottle is also available.



Massload

CL-KA98

Tempus
Building A- B1F - Hall 6, 7

Among Massload's latest products is one of the most economically-priced e-bike kickstands on the market. The CL-KA98 mounts on the chainstays via two holes spaced 18 mm apart (CL-KA100 is 40mm apart). Despite the competitive pricing of the kickstand, it still offers such features as tool-free length adjustability and increased strength. Massload's CL-KA98 comes in either ED black or silver, with other colors also available.

+886-4-7994988

www.cl-massload.com.tw



Ilumenox

Sheild (SS-L127SWE)

Evergreen
Booth A11 & A22

Ilumenox's Sheild headlight is compatible with Shimano StePS, Bosch, Panasonic and Bafang systems. A Cree White LED illuminates with a brightness of 22 Lux. A reflector is optional. This headlight meets the German standard, K1206.

+886-4-27065885

www.ilumenox.com



Sunny Wheel

SW-BM-115

Evergreen
3F No.336

Sunny Wheel's new SW-BM-115 is a rear view mirror that can be used not only for CTBs – it can be mounted on the handlebars of road bikes and e-bikes, as well. This customized e-bike mirror can be designed according to the customer's bike or the brand image. All of the rear view mirrors are E-mark approved.

+886-4-7616188

www.sunnywheel.com.tw



Sunny Wheel**Grip sets**

Evergreen
3F No.336

Sunny Wheel is now providing a full range grips for CTBs, road bikes (grip tape) and MTBs, made from various materials, such as TRP / EVA / Silicone, etc. The different characteristics of each material guarantee a comfortable and long lasting product – a lifetime grip for your bike. Sunny Wheel also appreciates cooperating with international customers on product design and production.

+886-4-7616188

www.sunnywheel.com.tw

**DNM****Burner-RCP3 Rear Shock**

Utilizing designs from their suspension forks, DNM is launching a rear shock designed for eMTB use. As eMTBs need more shock absorption, DNM has given the Burner-RCP3 a special piston design to buffer impact forces instantly and so allow for greater riding comfort. The shock body is manufactured from aluminum 7075 and offers travel of 56 to 86 mm. With additional features of rebound, compression, air spring and preload adjustment the Burner-RCP3 weighs just 380 grams.

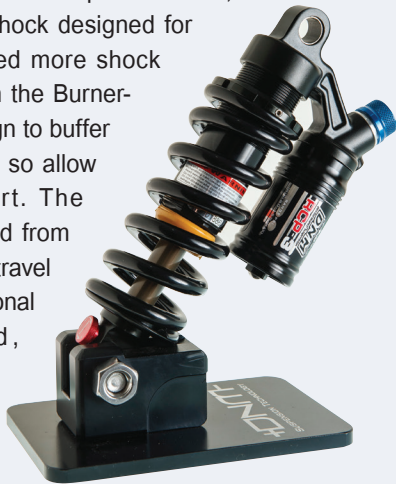
**Bengal****Ares 3**

Splendor
Booth 1305

Ares 3 is Bengal's open hydraulic disc brake system developed specifically for XC, Trail and All-Mountain bicycles.

The aluminum forged master cylinder has a reach adjustment feature, while the forged caliper allows for easy brake pad replacement via an EZ-out design. The Ares 5 also features a window for cleaning out mud and inspecting for worn-out pads.

+886-4-7203979

www.bengalperformance.com.tw

**GMD****Galaxy (G502)**

Splendor
11F No.1119

GMD's new Galaxy tire features a new racing compound which helps provide both longevity and low rolling resistance. The central cross-patterned, bi-directional tread pattern offers superior drainage and grip performance, while the classic diamond profile of both lateral surfaces ensures extra safety from skidding while cornering. The tire is available in sizes of 700 x 23C, 700 x 25C and 700 x 28C.

+886-49-2762306

www.gmd-tire.com.tw

**C.D. Components Co., Ltd.****CD-615**

CD-615 is a new handlebar bell from C.D. Components. The bell features a brass dome with a diameter of 21 mm. The Bell fits on handlebars diameters of 22.2~31.8 mm.

+886-4-76896586

**MHL****Bolton B-77 Saddle Bag**

Splendor
Booth 1315

MHL's new arrival is the Bolton saddle bag. The bag is manufactured from PET fibers, recycled from bottles and genuine leather into a stylish design that is aesthetically pleasing, useful and environmentally friendly. The style of the Bolton is particularly suited to urban bicycle use.

+886-4-26991719

www.mhlshop.com.tw



Ilumenox**Slash (SS-L315E)**

Evergreen
Booth A11 & A22

This Ilumenox's tail light is compatible with Shimano StePS, Bosch, Panasonic and Bafang systems. Three super bright red LEDs give the Siren a brightness of 18,000 mcd. The tail-light has 50 mm C-C mounting holes and comes with a German standard reflector.

+886-4-27065885

www.ilumenox.com

**Yu-Hub****XRC-R08**

Tempus
B1F

Yu-Hub's latest rear QR-type hub for road bikes is a straight-pull flange design. The XRC-R08 features a Shimano 3-pawl cassette design and weighs just 230 grams. Specifications are M10 x 24H x 130W.

+886-4-8811739

www.yuhub.com.tw

**Tranzx****JD-YSP19**

With a stealthy and clean look this adjustable height post provides great comfort for all riding positions.

+886-4-7681756

www.tranzx.com

**DNM****USD8A Dual air sprung fork**

The USD8A is a dual air sprung design fork that gives the feel of damping, rebound and compression similar to coil springs but at a greatly reduced weight. The dual sprung system also provides riders with a superior range of setup and tuning options. With a weight of 3,300 grams, this inverted fork is compatible with dual disc brakes.

**Duro****Cypher**

Evergreen
A-10

Designed from bikers' riding experiences, Duro's Cypher is a MTB tubeless-ready tire designed specifically for All-Mountain use. The tire offers high gripping performance and enhanced puncture protection.

+886-4-8520121

www.duro.com.tw

**Atop****AA17**

Atop system AA17 reel knob lacing system is widely used on bicycle products and outdoor sporting goods. It comes with an accessory package that allows both OE factories and end-users to easily take it apart to change the reel knob quickly. The adjustment knob is very comfortable to touch, giving this reel knob a very good reputation globally as an aftermarket product.



I-Ling

DSS-R48

A unique integrated alloy beehive structure helps prevent heat build up on these disc brake pads. The aluminum beehive shape has better heat dissipation and helps avoid brake failures due to overheating, while at the same time it ensures consistent brake power. The metal pad also offers increased high durability and longer life.



Scada

SC-CC821

Tempus
B1F No.4&5

The surface of Scada's new stylish pedals is coated with a durable, long-lasting, slip-free sand-paper from 3M to offer a premium design for urban, trekking and e-bikes. The flat profile provides an even contact patch enhancing both safety and performance. As the icing on the cake, the SC-CC821 weighs in at only 315 grams per pair.

www.scada-tw.com



Ridea

C88 Pulley Wheel

Ridea has developed a series of pulley wheels offering increased chain power and reduced chain friction and noise. The carbon fiber C88 features all-ceramic resistant-free bearings and 18-tooth wheels with X-shaped teeth to give riders stable shifting. The C88, which weighs in at 85 grams, is available in Shimano, SRAM or Campagnolo compatible versions.



QBEST CYCLE

QBA-UMS05

The QBA-UMS05 is an integratel stem mount for universal cycling computers (Garmin or Bryton). It is for use with an original plastic insert kit only. An additional bracket for a GoPro camera or head light is also available.



1921

MUDGUARDS · CHAINGUARDS · PUMPS

Made in Germany

INTEGRATED
E-BIKE SOLUTIONS

CABLE ROUTING
»E-CHARGE«

NEU
NEW

CHAINBLADE_E FOR E-BIKES

- YAMAHA
- SHIMANO
- BAFANG
- BELT DRIVE
- BOSCH

EVERGREEN HOTEL
PEONY BALLROOM //
3 RD FLOOR// D03

TAICHUNG

18.-21 OCT. 2016

SKS-GERMANY.COM

European Bike Market Remains Steadfast

2015 proved to be a stable year for the EU bike industry. According to figures published by CONEBI in its annual Bicycle Industry and Market Profile, 20,751,000 bicycles and e-bikes were sold in the EU during 2015, a 2% increase on the 20,340,000 sold in 2014. Of these, 13,149,000 were produced in the 28 countries of the European Union—up over 10% on the EU's bicycle production total of nearly 12 million in 2014.

Sales of e-bikes were a large contributing force to the health of bike market in Europe. According to CONEBI's figures,

EU e-bike sales rose by over 19% last year to 1,357,000 units. 70% of these were sold in just three countries—Germany, Netherlands and Belgium. However, as the various bicycle industry associations in the EU have been releasing national bicycle statistics throughout 2016, most of them share one thing in common – bicycle sales are flat, and e-bikes sales are flourishing. Since 2010, e-bike sales in Europe have more than doubled.

Increasing Import Value

According to data from

Eurostat, the EU imported a total of 8,195,210 bicycles and e-bikes from outside the EU in 2015. This is a small (1.7%) increase from the 8,055,933 units imported in 2014. However, of this total quantity, 720,883 were e-bikes, a large (71%) increase from the 420,249 e-bikes imported into the EU in 2014. The total value of imported bikes and e-bikes into the EU in 2015 was €1,525,895,722. This was a hefty (25.8%) increase on the €1,212,731,738 total value of bikes & e-bikes imported into the EU in 2014.

Of the above 2015 total import quantities, 7,474,327 units

were bicycles, 2% down from the quantity of bicycles imported into the EU in 2014. However the average value per unit rose to €166, resulting in a total value of bicycles (not including e-bikes) into the EU of €1,238,418,147, an increase of over €200 million (8.8%) over 2014. The top two extra-EU originating countries for EU bike imports in 2015 were Taiwan, with a 25% share, and Cambodia, with a 19% share by quantity; and a 47% and 25% share respectively by total value.

EU 4-year History of Bicycle & E-bike Extra-EU Imports by Quantity

Imported Category	2012 (units)	2013 (units)	2014 (units)	2015 (units)	2014~2015 % Change	2015 % Share	Average Value (€)
Bicycles	8,334,315	7,463,510	7,635,684	7,474,327	-2.11%	91%	€166
E-bikes	364,609	405,708	420,249	720,883	71.54%	9%	€399
Total	8,698,924	7,869,218	8,055,933	8,195,210	1.73%		

Source: Eurostat

EU 4-year History of Originating Countries for Extra-EU Bicycle (excl. e-bikes) Imports by Value (€)

Country of Origin	2012 (€)	2013 (€)	2014 (€)	2015 (€)	2014~2015 % Change	2015 % Share
Taiwan	590,808,979	494,938,885	485,794,573	576,780,980	18.73%	46.6%
Cambodia	173,201,140	245,573,540	233,742,567	312,349,506	33.63%	25.2%
Bangladesh	41,458,911	45,427,065	55,104,703	73,718,049	33.78%	6.0%
Turkey	21,420,085	28,083,242	36,430,290	45,473,576	24.82%	3.7%
Thailand	44,867,913	47,507,142	54,552,760	44,812,887	-17.85%	3.6%
Philippines	28,900,323	34,591,871	38,889,107	40,717,693	4.70%	3.3%
Tunisia	29,884,273	22,379,903	27,870,504	33,516,164	20.26%	2.7%
China	21,386,543	20,528,866	18,008,232	25,135,943	39.58%	2.0%
Indonesia	57,370,122	28,071,848	19,038,001	23,168,741	21.70%	1.9%
Sri Lanka	44,540,023	18,170,431	18,446,058	20,642,636	11.91%	1.7%
Vietnam	14,362,155	9,368,360	17,983,483	18,628,675	3.59%	1.5%
Other	27,229,199	22,471,934	25,909,755	23,473,297	-9.40%	1.9%
Total	1,095,429,666	1,017,113,087	1,031,770,033	1,238,418,147	20.03%	

Source: Eurostat

EU 4-year History of Bicycle & E-bike Extra-EU Imports by Total Value

Imported Category	2012 (€)	2013 (€)	2014 (€)	2015 (€)	2014~2015 % Change	2015 % Share	Average Value (€)
Bicycles	1,095,429,666	1,017,113,087	1,031,770,033	1,238,418,147	8.80%	81%	€166
E-bikes	194,413,123	155,191,509	180,961,705	287,477,575	58.86%	19%	€399
Total	1,289,842,789	1,172,304,596	1,212,731,738	1,525,895,722	25.82%		

Source: Eurostat

EU 4-year History of Originating Countries for Extra-EU Bicycle Imports by Quantity

Country of Origin	2012 (units)	2013 (units)	2014 (units)	2015 (units)	2014~2015 % Change	2015 % Share	Average Value (€)
Taiwan	2,425,945	1,879,522	1,861,679	1,839,612	-1.19%	24.6%	€314
Cambodia	947,033	1,393,440	1,208,399	1,380,148	14.21%	18.5%	€226
Philippines	651,876	793,039	912,196	849,357	-6.89%	11.4%	€48
Bangladesh	472,355	534,057	661,468	747,867	13.06%	10.0%	€99
China	450,224	581,372	444,290	495,542	11.54%	6.6%	€51
Thailand	657,320	644,882	686,817	466,479	-32.08%	6.2%	€90
Tunisia	446,180	346,192	424,239	424,486	0.06%	5.7%	€79
Sri Lanka	946,438	391,957	388,861	379,442	-2.42%	5.1%	€54
Turkey	209,460	241,023	307,238	315,483	2.68%	4.2%	€144
India	163,029	201,158	202,974	197,061	-2.91%	2.6%	€42
Indonesia	623,905	248,626	168,843	163,257	-3.31%	2.2%	€142
Vietnam	108,875	64,772	118,768	103,511	-12.85%	1.4%	€180
Other	231,675	143,470	249,912	112,082	-55.15%	1.5%	€209
Total	8,334,315	7,463,510	7,635,684	7,474,327	-2.11%	100%	€166

Source: Eurostat

Extra EU imports of e-bikes rose dramatically in both total quantity and total value in 2015. A total of 720,883 e-bikes were

imported into the EU in 2015. This is a big (71%) increase from the 420,249 units imported in 2014, and over 50% of the

1,357,000 units reported by CONEBI to be sold in the EU in 2015. The total value of e-bikes imported rose by 58.9% to

287,477,575, indicating that the average value per unit imported was €399.

EU 4-year History of Extra-EU E-Bike Imports by Quantity

Country of Origin	2012 (units)	2013 (units)	2014 (units)	2015 (units)	2014~2015 % Change	2015 % Share	Average Value (€)
China	296,602	343,812	340,267	533,065	56.66%	73.9%	€356
Vietnam	15,751	18,582	37,892	74,259	95.98%	10.3%	€539
Hong Kong	259	1,787	463	51,275	10,974.51%	7.1%	€110
Taiwan	18,169	23,313	21,335	39,126	83.39%	5.4%	€634
Switzerland	273	352	883	14,223	1,510.76%	2.0%	€1,399
Japan	31,078	13,007	16,994	4,218	-75.18%	0.6%	€1,406
Other	2,477	4,855	2,415	4,717	95.32%	0.7%	€341
Total	364,609	405,708	420,249	720,883	71.54%		€399

Source: Eurostat

EU 4-year History of Originating Countries for Extra-EU E-Bike Imports by Value (€)

Country of Origin	2012 (€)	2013 (€)	2014 (€)	2015 (€)	2014~2015 % Change	2015 % Share
China	122,397,160	112,886,299	130,421,590	189,561,645	45.35%	65.9%
Vietnam	11,995,678	9,260,454	16,477,398	40,024,985	142.91%	13.9%
Taiwan	10,241,734	12,943,327	13,278,483	24,787,758	86.68%	8.6%
Switzerland	285,463	207,308	1,006,996	19,904,318	1,876.60%	6.9%
Japan	47,339,188	16,890,673	18,652,064	5,928,600	-68.21%	2.1%
Hong Kong	200,744	772,289	165,374	5,661,418	3,323.40%	2.0%
Other	1,951,144	2,229,146	957,786	1,606,836	67.77%	0.6%
Total	194,413,123	155,191,509	180,961,705	287,477,575	58.86%	

Source: Eurostat

Poor weather and over-supply affecting 2016

CONEBI's 2015 EU bicycle production figure of 13,149,000 units combined with Eurostat's 2015 extra-EU imports data of 8,195,210 gives a total of 21,344,210 bicycles and e-bikes supplied to the EU market in 2015. CONEBI's EU sales figure of 20,340,000 units would tend to suggest that the EU market became over-stocked in 2015.

Although, EU production data for first half 2016 are not available so far, import data from Eurostat show that extra-EU imports of bicycles were down by nearly 7% in total quantity in the first six months of 2016. First-half 2016 financial reports from both Shimano and Accell have referred to the poor weather seen by many European countries in the earlier part of the year affecting sales.

Imports of e-bikes are continuing to rocket upwards. 550,955 e-bikes have been imported into the EU in the first six months of 2016—an 84% increase on the quantity imported during the same period in 2015. In the first half of this year, nearly one in every eight bicycles imported in the EU was an e-bike.

Jan to Apr 2016 Bicycle and E-Bike Imports into the EU by Quantity

	Jan~Apr 2015	Jan~Apr 2016	% Change
Bicycles	2,923,478	2,540,119	-13.11%
E-bikes	195,517	352,072	80.07%
Total	3,118,995	2,892,191	-7.27%

Source: Eurostat

Jan to Apr 2016 Bicycle and E-Bike Imports into the EU by Total Value

	Jan~Apr 2015	Jan~Apr 2016	% Change
Bicycles	€494,391,360	€468,040,280	-5.33%
E-bikes	€100,498,742	€153,681,564	52.92%
Total	€594,890,102	€621,721,84	4.51%

Source: Eurostat

Country Briefings

Germany



The German Bicycle industry association, ZIV, reported this year that the mobility behavior of the Germans is changing rapidly, particularly in urban areas. The car is becoming less the transport mode of choice, while the bicycle is becoming more popular.

2015 was a successful year for bicycles in Germany, with ZIV estimating the annual

turnover of the bicycle, parts and components industry at approximately € 5 billion. 4.35 million bicycles and e-bikes were sold in Germany in 2015—a growth of 6.6% from the previous year. The e-bike boom is continuing unabated. In 2015, 535,000 e-bikes were sold—an 11.5% growth on 2014's 480,000 units. Proportionally, 12.5% of all bicycles sold in Germany are e-bikes.

German municipal and federal governments continue to develop greater infrastructure for bicycles and e-bikes. Last December saw the opening of the first section of a 100km

bicycle 'autobahn' through the heart of the heavily-populated Ruhr valley. Other German cities are now also looking at developing better cycling infrastructure.

So far in 2016, conditions have not been ideal for continuing the growth of bicycle sales in Germany, which saw inclement weather in the first part of the year. According to Eurostat, in the first four months of this year, German imports of bicycles (excluding e-bikes) were down by 10% in total quantity and down by about 1% in total value compared to the same period in 2015.

UK



According to CONEBI figures, just over 3.5 million bicycles were sold in the

UK in 2015. Eurostat import data shows that the UK imported nearly 3.2 million bicycles at an average value of €151.03. While growing slightly in 2015, UK domestic production of bicycles remains a tiny percentage of overall bike sales.

The Brexit referendum result to leave the EU has affected both share prices and the value of the pound. Although many share prices have now

recovered, the pound remains at levels approximately 12% lower than pre-referendum levels. Bicycle importers, distributors and retailers are raising prices in the face of increased supply costs.

An estimated 20 to 25% of all bicycles sold in the UK are through the country's largest bicycle retailer, Halfords. Affected by the Brexit referendum and struggling to shore up sales in its bicycle division, Halford's share prices have fallen by over 30% in the past 12 months. Halford's, along with many in the UK bike industry, will hope successful results for the UK in the Tour de France and Olympic cycling events will translate into increased participation and bicycle sales in Britain.

Earlier this year the two largest UK online retailers Wiggle and Chain Reaction announced their intention to merge. The combined businesses are expected to have an annual turnover in excess of £300 million.

In the first 4 months of 2016, bicycle imports into the UK from outside the EU were down by 16% in total quantity, and 5% in total value compared to the same period last year, according to Eurostat data.

The Netherlands



While the total quantity of bicycles sold in the Netherlands fell slightly, an increase in the average price per bike meant that total sales volume of bicycles for the country also increased during 2015.

According to Dutch industry associations BOVAG and RAI, a total of 983,000 new bikes were sold in the Netherlands in 2015. This represents a fall of 6.4 percent from 2014 and a drop to under 1 million units for the first time in recent years. However, total

turnover from bicycle sales rose to €899 million, aided by the particularly strong growth of e-bike sales, which now represent almost one in four of the new bikes sold in Holland.

Last year a total of 276,000 new e-bikes were sold, up 23.6 percent over the previous year. RAI also noted the ever increasing variety of e-bikes being sold, with folding bikes, cargo bikes and road bikes all becoming available with electric assist.

According to the latest data available for Eurostat, the first 4 months of 2016 have seen bicycle imports (non-electric-assisted) from outside the EU decrease by over 12% in total quantity and 1% in total value compared to the first 4 months of 2015.

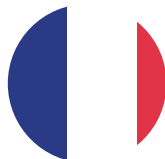

France

Figures released by the French bicycle & sporting goods industry associations, Univelo and FPS show slight growth in the French bicycle market in 2015.

According to the figures released a total of 2,996,015 bicycles were sold in France last year—up 0.5% from 2014. The depreciation of the Euro against the US dollar led to the average price per bicycle increasing by 4.5% to €331. Total value of complete bikes sold on the French market was €961.6 million—also an increase of 4.5%. The total value of bicycle parts and accessories sold in 2015 also rose by 4.5% to 728.9 million euros.

As in other European countries, E-bikes are also continuing to gain popularity in France. According to the Univelo data, a total of 102,000 E-bikes were sold in 2015—and increase of over 30% for the 2014 figure of 78,500 units.

The quantity of bicycles (not including E-bikes) imported into France from both inside and

outside the EU in the first four months of 2016 have increased by 22% compared to the similar period in 2015, according to Eurostat data. Total value of bicycle imports in the time frame has increased by 6%.

Italy



According to data from CONEBI, a total of 1,653,709 bicycles were sold in Italy during 2015, 2.24% down from the 1,695,000 bicycles sold the previous year. Of these, 56,189 units were e-bikes. Total value of bike sales last year remained the same as 2014, at €488 million.

In terms of quantity, Italy remains as the EU's largest manufacturer of bicycles. However, in 2015, bicycle production fell by 14% to a total of 2,344,000 units, down from 2,729,000 the year before.



Spain

According to figures released by the Spanish bicycle industry association, AMBE, 1,103,839 bicycles were sold in Spain last year. Although this is just 1.4% over the 1,089,000 bicycles sold in 2014, the total value of all bicycle products sold in Spain during 2015 was €1,471 million, over up 8% compared to 2014.

In previous years, sales of e-bikes have been slower to take off than in more northerly European countries. However, 2015 saw e-bikes sales rocket up by over 39% with nearly 25,000 units being sold at an average value of €1,461.

In the first four months of 2016, total imports of complete bicycle (excluding e-bikes) into Spain were down by over 7% compared to the same period in 2014, according to Eurostat data, while the total value of those imports was up by over 7%.

Portugal

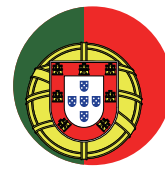

EU bicycle manufacturers, Accell and Decathlon have joined forces with the European bike industry publication, Bike Europe, in an effort to encourage suppliers to set up production/warehousing facilities within the EU, in order to decrease supply times. Portugal's 'bike valley' in Agueda has been a major focal point for these programs.

Last year, according to CONEBI statistics, 1.9 million bicycles were manufactured in Portugal, up from 720,000 in 2014—a 163% increase.

However, according to Eurostat, bicycle exports from Portugal in 2015 remained at a roughly similar level to 2014 - around 1.4 million units at an average per unit export value of approximately €133.

Switzerland



Recent statistics released by VeloSuisse, the association of Swiss bicycle suppliers, reveal that in a predominantly flat overall Swiss bicycle market, e-MTBs are showing the most market growth.

According to the released data, a total of 323,059 bicycles were sold on the Swiss market last year, down slightly from the total sales of 325,908 units in 2014. However, e-bikes continue to be proving popular, especially e-MTBs, of which 19,687 were sold in 2015, a 43% increase from 2014 sales of 13,697 units.

E-bikes in general continued to gain market share over non-powered bicycles in the Swiss market. The city bike category was able to maintain market share, while the city e-bike share grew compared to the previous year.  WG

The Polish Cycle Industry: Developing at a Steady Pace



▲ The simple yet solemn opening ceremony for the Kielce Bicycle Fair. ▲ First from right is Zbigniew Sosnowski President of Kross, Krzysztof Dylewski (center) took the baton as head of the Polish bicycle association (Polski Stowarzyszenie Rowerowe—PSR) from former director Jan Zasada (2nd from left) this year. Polbike President, Juliusz Kabath (1st on left) and PSR Vice President, Mateusz Pytko (2nd from right) are also shown here.

Poland is Eastern Europe's largest and most stable country, and bicycle production and sales have passed the one million unit mark. Poland produced 1.21 million bicycles in 2015, making it the EU's fifth-largest producer. Although retail prices average €385, second-hand bicycles account for 20-25% of the market, which is higher than in France, Britain, and Italy. Trekking, city bikes, MTBs, and children's bikes are most popular in Poland, and sales of 29" big tire and fat-tire bikes have also grown. Bright neon colors, such as neon green and neon orange, are currently in vogue. Because e-bike sales are continuing to grow in Germany and the Netherlands, e-bikes are receiving considerable attention in Poland: Romet focused on promoting e-bikes this year, and received the new product award at the Kielce Bike Expo.

Poland has a population of 38.6 million, and has growing consumer power. Although the country's bicycle market developed later than the western, northern, and southern European markets, the government has been actively establishing

green bicycle routes and bicycle rental systems, which have helped cause the popularity of cycling to soar, and enable the cycle industry to achieve steady development. As a result, Poland has become a battleground for Europe's leading brands. Poland has over 30 bicycle manufacturers. According to Krzysztof Dylewski, the new director of the Polish bicycle association (Polskie Stowarzyszenie Rowerowe—PSR), there are approximately 10 bicycle firms producing at least 5,000 bikes annually, and 12 firms producing more than 10,000 bikes annually. Most of the country's bicycle firms only make 2,000-7,000 bikes each year. The majority of these companies are OEM producers, and a few have their own brands. Apart from a main brand, some bicycles makers also have a secondary brand to differentiate certain products. For instance, Kross also has the "L.E Grand" brand, which is chiefly used on its city bikes, and Zasada also has the "Maxim" brand, which emphasizes style and innovation.

Poland has approximately 2,500-



▲ According to the organizers of Kielce Bike Expo, 242 firms took part this year, and this figure was a 20% increase compared with last year. Shown here are Director Joanna Marcejan (left) and Deputy Director Bartek Terlecki (right).

2,700 dealers, and most firms, including both manufacturers and distributors, have their own dealers. Depending on size, whole bicycle producers may have 200-600 dealers, while distributors may have 80-250 dealers. Apart from mass merchants (for instance, Maries also sells bicycles), sporting-goods stores such as Decathlon and Gosport also sell many bicycles.

Complete Bicycles

According to the latest CONEBI statistics, Polish bike manufacturers produced 1.21 million units in 2015, an increase of 20% from the 1 million units produced in 2014. Although the development is not as early as Western or Southern Europe, in the past five years, Poland has maintained a steady and stable growth. PSR President, Krzysztof Dylewski stated that 10 companies in Poland produce over 5,000 units.

Romet

Romet and Kross are equally matched rivals. Romet focus primarily on exports, but also has considerable domestic sales. Because Romet also produces motorcycles, it has a combined total of 500-600 motorcycle and bicycle dealers. It has two bicycle plants and one motorcycle plant; annual bicycle production is around 400,000 units and employees number 700. Romet is actively promoting e-bikes this year.



▲ Romet President, Wieslaw Grzyb likes riding horses and cycling.



▲ Romet promoted e-bikes at this year's Kielce Bike Expo.

Kross

Kross is the most distinctive brand on the domestic Polish market, and the company has also introduced the "L E · Grand" brand. Kross' two brands are big attractions for dealers. The company has 500 dealers and 500 employees, and produces close to 400,000 bikes annually. Second-generation managers are actively participating in the company's sales and administration.



▲ Kross Manager, Kacper Sosnowski is the son of the company's founder, and is a board member.



▲ LE · Grand is Kross' other brand, and is chiefly used for city bikes.

Zasada

Zasada has consistently had a stable output of 60,000-75,000 bicycles annually, and also owns the "Maxim" brand. Company President Zasada resigned as director of Poland's PSR bicycle association in March of this year. Zasada made a great contribution to Kielce Bike Expo, and many participating vendors attended at his invitation; he is a much respected figure in the Polish cycle industry.



▲ Zasada bike President, Jan Zasada.



▲ Maxim introduced a city bike with soft bright colors.

Unibike

Unibike assembles roughly 40,000 bicycles annually and is also a distributor for major brands. Unibike's president is Ms Krystyna Orfowska, but the company is actually run on a day-to-day basis by General Manager Zbigniew Lewandowski. Unibike is a conservative, successful company, and received the new product award at the Kielce bicycle fair.



▲ Unibike is well-managed and has a good reputation. Shown here is President, Krystyna Orfowska.



▲ Unibike produces approximately 40,000 bicycles annually, and is also an agent for Schwaber. Shown here are President Krystyna Orfowska (center), General Manager Zbigniew Lewandowski (left), and Marketing Manager Marcin Augustynowicz (right).

Folta

Folta assembles 15,000 bicycles each year, has around 200 dealers, and owns its own brand. The company's chief markets consist of Poland, Lithuania, and Latvia. It has 30 employees, and mainly imports parts from Taiwan and China. According to President Jarostaw Folta, economic conditions were relatively good this year, but the Polish zloty has been relatively unstable during the past few years, and many importers have been forced to make purchases using dollars. In the most extreme cases, importers must use dollars for 80% of their purchases. Folta feels that although the EU's cancellation of anti-dumping duties on Chinese bicycles will lead to greater competition, it will be a win for consumers if they have access to more good-quality, reasonably-priced bikes.



▲ Folta assembles 15,000 bicycles annually. Shown here are President Jarostaw Folta and Sales Manager, Piotr Zebrowski (right).

Showa

Chief executive Edy Hung is from Taiwan. Hung originally had five OEM bicycle plants in Poland, but all five declared bankruptcy. Hung then shifted to assembling bikes in 2011, mostly using parts from China. The company's brand name is "Rayon." Apart from meeting its own assembly needs, Showa also helps other small assembly plants in Poland to import parts. According to Hung, Showa has an annual output of 50,000 bikes, which are chiefly sold in Poland; these bikes mostly consist of mid-/low-price models, and are priced at €100-300. The company has 20-30 employees during the slow season, and 50-60 employees during the busy season. Hung emphasizes that although Showa makes low-end models, they are not sold in hypermarkets.



▲ According to Showa Manager, Edy Hung, the company assembles 20,000-30,000 bicycles annually.

Brat

Brat is run by a pair of brothers: younger brother Wikior Beska is the president, while older brother Karol is the general manager. The two brothers work together well in the management of this company, which assembles 10,000-20,000 bikes annually.



▲ Brat assembles 10,000-20,000 bicycles annually.

Ideal

Ideal did not participate in Kielce Bike Expo during the last two years, only sending personnel to visit the show. According to Sales Director Katarzyna Matusiak, the company did not participate because it does not have its own brand, and also wanted to safeguard its customers. Ideal moved to its current plant (8,000 m²) four years ago, and assembles 50,000 bicycles annually. It has 100-120 employees, and does not paint its frames in-house. It only imports frames and parts from Taiwan and China, and its chief



▲ According to Katarzyna Matusiak, Sales Director of Ideal's Polish plant, Ideal produces 50,000 bicycles annually in Poland.

markets consist of European countries such as Germany and Switzerland.

Dowstar-Olesno

Founded in 2007, Dowstar-Olesno assembles 5,000-6,000 bicycles annually and employs 20 persons.



▲Dowstar-Olesno assembles 5,000-6,000 bicycles annually

Simpla

Simpla produces mudguards, which are sold in Eastern and Western European markets, including Poland, the Czech Republic, and Russia.



▲Simpla produces mudguards, which are chiefly sold in Eastern and Western European countries such as Russia and the Czech Republic. Shown here are Sales Director, Ilya Sadritskiyi (1st on the left) and President, Vladimir Sadritskiyi (2nd from the left), Simpla CEO, Andrzej Murawski (center), Simpla Export Agent, Jan Pavlicek (2nd from the right), and Simpla Production Director, Robert Polaik (1st on right).

Components

Poland produces few parts, and according to CONEBI statistics, Polish parts account for only 2% of the entire parts output of all 28 EU states. The three parts manufacturers exhibiting at Kielce Bike Expo were ABI, SIHD, and Simpla.

Distributors

Distributors have sprung up quickly in Poland during the last few years, and are distributing a growing number of brands. Some distributors have even introduced their own brands (such as Polbike's Saveno brand and Aliot's Prox brand).

ABI

Krzysztof Dylewski President of the Polish Bicycle Industry Association (PSR). Krzysztof Dylewski owner of ABI. ABI produces 800,000 pieces of bicycle saddles per year. It employs 32 workers. ABI was founded in 2007 and will celebrate its 30th birthday. Main customers are OEM from Poland and EU.



▲ABI President Krzysztof Dylewski is also President of PSR. ABI produces bicycle saddles.

Krzysztof Dylewski owner of Leader. Leader company produces bikes under the brand Pin Up Girl, saddles under the brand name Maestro and is an importer / distributor in the Portuguese company Polisport in Poland.

Polbike

Polbike is an agent for Asian brands such as Raleigh, and also sells products under its own "Saveno" brand. According to President Juliusz Kabath, Polbike sells 15,000 bicycles annually, and the chief assembly firms for the Saveno brand include Bulgaria's Maxcom and Cambodia's Asama.

SIHD

SIHD produces many products, including carriers and mudguards, etc. Apart from Poland (80 customers), SIHD has 100 customers in the EU.



▲SIHD produces carriers and mudguards, etc.



►Shown here are Polbike President, Juliusz Kabath (on the left in the front), Mrs. Kabath (on the right in the front), and MTB Style Manager, Dutkiewicz Dartlomici (rear).

Ajlot

Ajlot is an agent for Asian brands such as Kenda and Velo, and also sells bicycles under its own Prox brand. According to President Jacek Balkowski, although the Prox brand has only been in existence for five years, an emphasis on quality has led to good sales. Ajlot has 400 dealers, said Balkowski, of which 100 are large. The company anticipates 5% growth this year, but profits may drop a bit. This is due to the depreciation of the zloty in April 2016, which forced Ajlot to raise prices by 6-10%. Nevertheless, Balkowski has great confidence in the development of bicycles in Poland.



▲ According to Ajlot President, Jacek Balkowski, his company expects 5% sales growth this year.

Taurus



▲ Taurus is an agent for the BMC, Kreidler, and Whispbar brands.

ITAI Bike

ITAI is an agent for Vee Rubber, Rodi, and Miranda.



▲ Shown here are Ital Bike President, Januse Mielcarski (left), Romet President, Wieslaw Grzyb (center), and Shimano EU International Account Manager, Clemens Ujejski (right).

Harfa

Founded in 1992, Harfa is a distributor for numerous brands, including SRAM, Mavic, BBB, and VDO, and its displayed products won an award at this year's Kielce Bike Expo. Harfa's manager is known to be very thorough and hands-on. The company has 500 dealers. The SRAM products of which Harfa is the agent have faced Shimano's flexible pricing strategy this year, which has made marketing very difficult.



▲ Harfa is an agent for numerous brands, such as SRAM, Mavic, BBB, and VDO.

Euro Bike

Euro Bike is RST's Polish agent, and also sells bikes assembled under contract.



▲ Euro Bike is an agent for SR Suntour, and also sells bikes assembled by other companies under contract.

CST & Merida Distributor

General Manager Piotr Wileska is an agent for CST and Merida, and two teams are in charge of product sales. As a result, Piotr had separate CST and Merida booths at this year's Kielce Bike Expo. The company has a little over 40 employees and 200 dealers. According to one of Merida's employees, who was present at the show, Merida sold approximately 30,000 bicycles in Poland last year.



▲ Piotr Wileska is an agent for CST and Merida.



▲ Merida's team at Kielce Bike Expo. Mike (2nd from left in the front row) noted that Merida sold 30,000 bicycles in Poland last year.

Cossack

Cossack sells bicycles from Eastern and Western Europe, including Germany, and according to our understanding is the Polish distributor for Germany's Sprix bicycles. According to Chairman Jacek Kozakiewicz, Cossack has 25 employees and close to 500 dealers throughout Europe.



▲ According to Cossack Chairman, Jacek Kozakiewicz, Cossack has 500 dealers throughout much of Europe.

Speed

Speed is an agent for Duro, Rowery, American Classic, and Vianor.



▲ Speed is an agent for the Duro, Rowery, Viandor brands. GM, Jan Golen is first on the right.

Monteria

Although Monteria participated in Kielce Bike Expo for the first time last year, it had a big presence at the show, displaying children's bikes, MTBs, and fat-tire bikes.

This year was the Kielce Bicycle Fair's seventh year. According to the organizers, a total of 242 companies participated in the show, which was an increase of 20% from the 200 participants last year. The show venue occupied an area of 110,000m². Apart from Polish bicycle firms, participating vendors also came from such other European countries as the Czech Republic, Germany, and Slovakia. More than 40 members of the Polish bicycle association took part in the show, and both Taiwan and China organized participating groups that consisted chiefly of parts manufacturers. There was a significant increase in the number of e-bikes on display this year, but no motorcycles were exhibited. Although Karbon had a large booth last year, they declined to participate this year, and rumor has it that they want to leave the bicycle industry. Shimano had an outdoor booth, and several other bicycle firms also displayed their product outdoors, using strings of balloons to attract attention. Most participating vendors had good opinions of the show, and expressed that they were looking forward to participating again next year. On the other hand, a minority of vendors had some complaints; for instance, Folta's sales manager expressed that the number of dealers visiting the show had fallen by 15-20% this year.

The Polish bicycle industry is rather conservative, and emphasizes steady development. Unlike in other countries, the Polish bicycle industry has not undergone



▲ Members of the Taiwan participant team at 2016 Kielce Bike Expo.

major fluctuations. Most companies expect to have 5-10% growth this year, or at least have flat sales. Although it is said that Poland had hoped to switch from the zloty to the euro sometime between 2019 and 2020, Britain's Brexit has thrown a new variable into the equation. **WG**



▲ Stars Circle General Manager, Fei Heying is looking for land in the Polish city of Poznan for rim factory.



▲ Wheel Top plans to open a plant in Romania. Shown here are President, Sung Fu-chiang (right) and the company's EU Sales Manager, Adan Dadsí (left).

A Lackluster 2016 Interbike



Interbike was held September 21-23 at the Mandalay Bay Conference Center in Las Vegas, and attracted 1,400 exhibiting firms. Major bicycle brands have been losing interest in this show over the last few years, and Giant and Felt were the latest companies to drop out. Due to a recent slump in the American market, bicycle sales have been consistently poor, and companies have cut back on their spending on the show. As a result, although the Outdoor Demo has always been one of the highlights of Interbike, the number of companies exhibiting at the Demo dropped this year. Together with Giant and Felt; Specialized, Intense, Santa Cruz, and Raleigh were also no-shows, and the bustling atmosphere felt in the past was gone. In spite of this, cycling buffs and dealers still showed undiminished enthusiasm for mountain bikes.

The most notable features of this year's show included 27.5" and 27.5+ MTBs, along with e-MTBs. Many brands introduced dropper posts, which have become standard equipment on MTBs. Fat-tire bike lovers were out in force, and there were even tandem and electric fatbike models on display. Road bikes equipped with disc



▲ About 100 companies participated in this year's Outdoor Demo, a slight reduction compared to previous years.

brakes were thriving, and included many cyclocross and gravel models.

In recent years, online shopping has flourished and become almost universal in the US, and more and more bicycle brands have introduced online sales systems. As a result, minimizing the impact on bricks-and-

mortar bike shops and striking a balance between physical and virtual channels will tax the management skills of many brands.

Next year's Interbike will be held in the same location on September 20-22, 2017. 



▲ Velo President's Assistant, Ann Chen received the '2016 Bicycling Industry Pioneering Woman' award on behalf of company President, Stella Yu.



▲ SR Suntour upgraded its Aion product line to 27.5+, with an inner diameter of 35mm for better rigidity.



▲ RST's Elev8 dropper seatpost is designed with an internal rectangular shaft that rolls on needle bearings to prevent twisting. The Elev8 comes in lengths of 80, 100, 125 and 155 mm travel.



▲ 2.8" and 3.0" widths of 27.5 sized tires were launched. Maxxis and Schwalbe were also exhibiting 2.6" tires in their booths.



▲ 27.5-inch MTBs predominated at this year's Interbike.



▲ 32 companies were located in Wheel Giant's Taiwan Pavilion in Zone E.



▲ Many people were lured by the attraction of free beer for Wheel Giant's Happy Hour.

Taichung Bike Week 2016
Evergreen Hotel, Booth No. A-10

Photo credit: Scott Marwenz



Hans Rey
Global Biking Legend



www.DURO.com.tw

“Free beer everyday
at 10-12 am & 1-3 pm!”



A-10

f DURO TIRE-華豐輪胎



SHOW DAILY Publisher

A&G

President & Publisher: Grace S. Ruan

Vice President: Jerry Wu

Editorial Director: Daphne Chen

International Business Correspondents: Robert Hornsey, Cary Charlebois

Translation Editor: Glen Lucas

Editorial Director: Sarah Chiang

Chief Editor: Bred Wu

Associate Managing Editor: Sony Chang

Editorial Captain: Saya Wu

Editorial Department: Ned Wu, Leon Wu, Yung Jen Lee, Alfred Tsai,
Chung Min Shih

Editorial Assistant: Ping Chou, Hsiang Chieh Wang

Digital Publishing Dept. Captain: Stan Hsu

Art Designer: Jin, Monica Lin, Tia Yu

Advertising: Joey Huang, Davy Lin, Rick Lin, Tom Lai, Melody Hsu, Scott Chiu,
Kevin Wu

Secretary: Jean Huang

Administration: Angela Chen, Emily Chen, Trina Ke, Jonathan Wang,
Catherine Chen

Computer Center: Robert Lin

Website: <http://www.biketaiwan.com>

E-mail: rep@mail.wheelgiant.com.tw

Head Office: 193 Tze-Chiang Rd., Changhua City 50095, Taiwan

Tel: 886-4-7350500, 7360794~5

Sales Dept Fax: 886-4-7357860 Editorial Dept Fax: 886-4-7360789

Taipei Branch Office: 7F., #80, Fushing North Rd., Taipei, Taiwan

Tel: 886-2-27522477, 27400737 Fax: 886-2-27733028

Shanghai Branch Office: Room 1802 Building 2, No. 999, Bailu South Road,
Kunshan District, Jiangsu, China.. Postal Code: 215500

Tel: 86-512-57515789, 86-512-57516309 Fax: 86-512-57515789-8899

Tianjin Branch Office: Room 3406, Unit 1, Building 17, Merchants Diamond
Hills, Olympic Sports Center East, Weijin South Road, Nankai District, Tianjin,
China Tel/Fax: 86-22-28137969

Shenzhen Branch Office: Room 2230-2231 Jin Xiu Jiangnan,
Meilung Rd., Lunghua Town, Baoan Dist., Shenzhen, China.

Tel: 86-755-28069189

Ningbo Branch Office: Room 2303, Building 1, Homei Garden No.666, Yangmuqi
Road, Ningbo, Zhejiang, China Tel/Fax: 86-574-88210669

Legal Advisor: Chenyi Law Firm, Chang Lee Chung

Printing: Chuen Fung Enterprise Co., Ltd.

For advertising information, editorial content and press releases,
please contact:

rep@wheelgiant.com.tw or daphne@wheelgiant.com.tw

www.biketaiwan.com

輪彥國際有限公司 WHEEL GIANT INC. 軟實力傳媒有限公司 Soft Power Media Co., Ltd.

Copyright 2016 by Wheel Giant Inc.
All Rights Reserved. Nothing in this magazine
may be reprinted in whole or in part,
by electronic retrieval or any other means,
without the express permission of the publisher.



BAFANG

Splendor Hotel
Booth No.1054&1055



MAX drive system

Powerful. Smooth. Silent.



MAX – the powerful drive system

Compatible with all customary frames
Low maintenance and easy to install



High-performance drive unit

Compact modular design



Easy to use HMI unit

Versatile, easy to read controller



Durable battery pack

Different power packs available, max. 690 Wh

www.szbf.com

The Flexible Partner for E-Bike Systems

**KEEP
FIGHTING**



VALKYRIE PRO

The Valkyrie is Kenda's all new high performance road tire - fast, reliable and light. It offers excellent rolling resistance, superior wet and dry grip and a very high level of puncture resistance!

www.kendatire.com

KENDA