

# Show Daily



Publisher: Wheel Giant Inc.

October 20, 2015



DAY

1

- 04 Taichung - The Bicycle-Friendly City
- 05 Cruising Altitude for TBW
- 07 Ride On Focusing on Increased Service
- 08 HL's Drift Fork Setting Milestones
- 10 SRAM Unveils Wireless Shifting
- 12 Huge QR Recall in US
- 14 Cionlli and Dow Polyurethanes Introduce Cooperative Olympic Promotion Project
- 15 RST Increase Hub Compatibility on Inverted Fork
- 15 Bosch Upgrade eMTB Drive System
- 16 TranzX Antishock Components
- 16 80th Birthday Celebration Dinner for Cionlli President
- 18 2015 Kielce Bike-Expo
- 19 2015 Formosa 900
- 20 2015 Cosmo Bike Show Indicates Upturning European Markets
- 21 Velo Bring Tomorrow's Technology to Today's Products
- 22 Full Reach's Ultra-Lightweight One-Piece Hub
- 22 Kenda Cup Getaway Ride Attracts 2000 riders
- 23 New Products 2016
- 27 National Taichung Theater Opens
- 28 Taipei Set for Velo-City
- 29 International Dining in Taichung

Photo credit by Doris Dunn



**RST**  
RACING TUBES & PARTS  
FOR BICYCLES ONLY  
www.rst.com.tw

Photo credit by Jan Tandler

**TranzX**  
inspiring your ride



# DROPPER POST

Freely and easily adapting your seat position according to the terrain you meet!

The MICRO adjustment offers quick and easy seat positioning, with reliable and robust technology – virtually No Play!



Tuesday, October 20, 2015

# Table of Contents

Taichung - The Bicycle-Friendly City	04
Cruising Altitude for TBW	05
Ride On Focusing on Increased Service	07
HL's Drift Fork Setting Milestones	08
SRAM Unveils Wireless Shifting	10
Huge QR Recall in US	12
Cionlli and Dow Polyurethanes Introduce Cooperative Olympic Promotion Project	14
RST Increase Hub Compatibility on Inverted Fork	15
Bosch Upgrade eMTB Drive System	15
TranzX Antishock Components	16
80th Birthday Celebration Dinner for Cionlli President	16
2015 Kielce Bike-Expo	18
2015 Formosa 900	19
2015 Cosmo Bike Show Indicates Upturning European Markets	20
Velo Bring Tomorrow's Technology to Today's Products	21
Full Reach's Ultra-Lightweight One-Piece Hub	22
Kenda Cup Getaway Ride Attracts 2000 riders	22
New Products 2016	23
National Taichung Theater Opens	27
Taipei Set for Velo-City	28
International Dining in Taichung	29



## TBW to Hold Welcome Party

On the evening of Wednesday 21 October, Taichung Bike Week has organized a Welcome Dinner Party for all exhibitors and visitors. The dinner is for pre-registered guests only and will be held on the 12F floor of the Splendor Hotel. The event will start at 18:30 after the close of TBW day 2.

**KSS**  
WWW.KSSUSPENSION.COM



**LEV**

THE LATEST **LEV** RETURNS IN ALL BLACK LIVERY SHEDDING OVER 50 GRAMS FROM ITS PREDECESSOR BY INTEGRATING A HIGH COMPRESSION CARBON FIBER HEAD CLAMP, RECOURSE ULTRALIGHT CABLE SYSTEM AND KGSL SUPERLIGHT REMOTE.

SEE THE ENTIRE LINEUP  
**A5F AMERICA ROOM**



▲ Taichung City Mayor, Lin Chia Long.

# Taichung - The Bicycle-Friendly City

With the rising popularity of sports trends and environmental awareness, bicycles, once a traditional means of transportation, are in transition to recreational and fashionable vehicles, which combine sports, leisure, fitness, recreation and environmental protection features. The bicycle industry has also been developing along with these changes of lifestyle, and has been contributing many measures to encourage cycling.

Taiwan's bicycle industry has done exceptionally well in global markets, and is the supply center for world's mid- and high-end bicycles. Sixty percent of Taiwan's bike industry is concentrated in central Taiwan. According to statistics, Taichung has outstanding bicycle and component production output and value, so it is no exaggeration to say that central Taiwan is the heart of the worldwide bicycle industry! The professional yearly trade show, Taichung Bike Week, provides an opportunity for the mid-/high-end bicycle brands to determine OEM specifications. Negotiations between buyers and component suppliers set bicycle specifications for the year after next, and it is due to Taichung Bike Week's pivotal role in the global bicycle industry, that it is so highly regarded by bicycle firms worldwide.

Taichung Bike Week will be held in four major hotels in Taichung, and has once again expanded for 2015 -- with over 400 exhibitors. We expect to attract more than 5,000 domestic and foreign buyers to come and

negotiate specifications for their new models. Taichung Bike Week has indeed become an ideal professional platform for Taiwan's OEM manufacturers to display their new products to global product managers. Taichung City Government began underwriting a portion of the event six years ago, offering important logistical support. This public service allows more domestic and foreign businesses to interact in a relaxed atmosphere and create more business opportunities. Over the past six years, the event has become highly appreciated by the global bicycle industry, and we have played our part in making TBW one of Taichung's most important annual events.

To compliment Taichung's solid bicycle industry foundation, the city has also developed an extensive network of bike paths, and the very convenient iBike public bicycle system. As a result, Taichung has become a bicycle-friendly city with a high quality of life. The Taichung City Government is now actively promoting "the Bicycle 369 Project", in which the "3" means the establishment of 300 iBike rental stations by the end of 2017, "6" stands for the establishment of bike paths with a total length of 600 kilometers, and "9" means the provision of more than 9,000 iBike bicycles. Visitors to Taichung Bike Week can find an iBike station located directly outside the Splendor Hotel. The iBike system enables members to rent a bicycle at one location and return it at another. Once we have established stations every 2-3 kilometers, bicycle transportation

will become extremely convenient for everyone, and will help resolve some of Taichung's transportation and traffic problems. Furthermore, the Taichung City Government is also planning the construction of a bicycle museum, and will develop bicycle culture under the existing foundation to grow with the bicycle industry.

Taichung had two bike paths that made the top ten in the internet-voting of the "Top 10 Classic Bikes Routes" national campaign. Second-placed in the whole nation was the Deng Feng Bicycle Green Way, while tenth was the Tanyashen Green Bikeway. The delightful scenery and views along the route of these two bike paths is loved by

everyone, and the high popularity of these two roads also shows the Taichung public's devotion to cycling life and support of the bicycle industry.

As the heart of Taiwan's bicycle industry, as well as the center for the global bicycle industry is in Taichung, I am quite confident the integration of industry, transportation, sports and life, will lead to greater development of the bicycle industry, help Taichung become a bicycle-friendly city, and let Taichung citizens be proud of their city.

I sincerely wish the exhibition of this year's Taichung Bike Week a great success and booming business for you all.

WG



▲ Taichung City Government's introduction of iBikes is helping transform Taichung into a more bicycle-friendly city.

# Cruising Altitude for TBW

In the past decade, Taichung Bike Week has grown from a few sales representatives renting a couple of Taichung hotel rooms to make sales presentations to visiting product managers to an event spanning three hotels that is unrivalled in terms of business productivity.

Organizing and overseeing the day to day running of the show are a group of bike industry volunteers who give up their free time to do tireless work ensuring the show runs smoothly and successfully. Not least among these is the Pro-Lite CEO, Steve Fenton, who has been involved with the event since its earliest days.

Steve took some time out of his busy schedule leading up to the show to answer some questions both about this year's event and future direction of Taichung Bike Week.

## How many exhibitors will be attending this year's show?

SF: "Once more, the hotels are booked to capacity. Approximately 247 brands are exhibiting at The Splendor Hotel again this year, with 100 brands at the Evergreen and a further 60 brands at the Tempus. So, in total there are slightly over 400 exhibitors"

## That is slightly more exhibitors than last year, isn't TBW used to more prodigious growth?

SF: "In its current format, TBW has reached its limits. All the hotels are full to capacity. However, where we are expecting to see larger growth is in the number of visitors. In addition to increased numbers of OE product managers, we are starting to hear of more distributors coming too. They are finding that if they can get a preview of aftermarket products in the pipeline for the coming year, they are able to give forecasts to suppliers earlier."

## Do you have any plans to add more hotels to TBW?

SF: "We would be happy to, after all TBW is essentially an umbrella group. However, if other hotels want to be involved they need to come and talk to us. In the past, we have seen hotels try to organize independently, and that has always failed for them, and it causes a concern for us, as their failure impacts negatively on the reputation of TBW."

## Do you have any news on the possibility of moving to the exhibition centre?

SF: "Not yet. We are looking at the situation and are talking with the city government

about it. There are advantages and disadvantages to moving an exhibition centre. Such a move would impact hugely on the nature of Taichung Bike Week, so we are taking into account what direction the bike industry as a whole wants to see TBW take in the future.

## 2015 TBW had to bring it forward by a couple of weeks, why did you do this?

SF: "We want to make the event more suitable for North American product managers. Last year we received numerous requests and suggestions to schedule the show earlier. After researching the popularity of the idea amongst exhibitors and visitors thoroughly, and getting only positive feedback to the concept, we decided to go ahead and arrange for these new dates at the end of October.

## Do you foresee further date changes for future shows?

SF: "I think we have it about right at the moment. However, timing really all depends on how SRAM and Shimano align their end-of-year cut off dates. American brands have an earlier cut-off date than other countries and we shall just have to see what happens in the future. We just keep our eyes and ears open, and listen to what people tell us."

## Are there any other changes to this year's show?

SF: "We have prevented certain exhibitors—who shouldn't have been let in last year, from exhibiting at this year's show. In 2014, they got in by providing information which



▲ Steve Fenton, CEO of Prolite, and Organizer of TBW.

satisfied our exhibitor entry requirements. However, once they displayed, we realized they shouldn't have been here.

## Why not just let them exhibit?

SF: "This was done in response to numerous exhibitor requests. It is really important that we maintain the integrity of the show. This is a bicycle industry OE trade show, and I am determined to keep it that way."

## Are there any other improvements that have been made for this year's show?

SF: "Most things now run like clockwork. Thanks to all volunteers who do a lot of unpaid and unrecognized work for TBW the behind the scenes. Most of the other changes are more minor like rearranging booths at the Splendor Hotel to allow more visitor movement."

## Last year's local elections returned a new Mayor of Taichung, has this affected the show?

SF: "No. The new Mayor has been very receptive to the show. At first the new City Government didn't really get the concept of an OEM trade show. But now that they do, they have fully embraced TBW, and come up with a whole range of things that they would like to contribute to. Mayor Lin's offer of support was overwhelming and very we gratefully received it." 🌟WG



▲ All TBW hotels are, once again, filled to capacity.

Splendor Hotel, 10F #1002

**SR SUNTOUR**



**REMY ABSALON**

SR SUNTOUR WERX ATHLETE

**WINNER OF THE 2015  
MEGAVALANCHE**

**REFINED SIMPLICITY™**

# Ride On Focusing on Increased Service

Ride On is once more returning to the Millennium Hotel, which last year provided very professional and punctual service to the large number of visitors who showed great interest in the format of the event's OEM presentations.

A new exhibitor in the Ride On group this year is Brose, the German e-bike component and drive specialists. Joining Brose in the group are returning exhibitors: Magura; Mavic; Fox; Vittoria Tires; Hayes Bicycle Group with Hayes, Answer, Manitou and Sunringlet; FSA Group with FSA, Vision, Gravity and Metropolis; Selle Royal Group with Selle Royal, Fizik, Brooks, Pedaled and Crankbrothers.

The format of this year's Ride On will remain similar to last year, with each exhibitor making two presentations per day at the Millennium Vee Hotel—one in morning, one in the afternoon, as well as having direct meetings in private rooms.

"Rather than any major

changes for 2015, we have focused more on improvement of the services, as our format worked very well last year" stressed Ride On organizer, Luca Conte. "Our target is to offer the best service in terms of product presentation, and in terms of facilities available for our guests. We have developed some small improvements in order to offer a further step up in terms of service."

Additionally, 2015 will see the return of the popular Taiwan Day at the Nan Shan Center on the first day of the show, where Ride On group's exhibitors will make presentations in Chinese completely dedicated to Taiwanese and Chinese Assemblers and Producers.

Official times for Ride On presentations are October 20th starting at 9:00 AM for Taiwan Day at the Nan Shan Center, and October 20th, 21st and 22nd starting at 9:00 AM for international presentations at the Millennium Vee Hotel, Taichung.

WG

## Daily Schedule for Ride On presentations at The Millennium Vee Hotel (Days 1, 2 and 3)

	Room 1	Room 2	Room 3
9:00~10:00	FSA	Fox	Magura
10:15~11:15	Hayes	Vittoria	Selle Royal / Fizik
11:30~12:30		Mavic	Crankbrothers
14:00~15:00	FSA	Fox	
15:30~16:30	Hayes	Vittoria	
16:45~17:45		Mavic	



▲ Once more, Ride On guests will be able to take advantage of a free shuttle van service provided by organizers, running between the Millennium Vee Hotel and other major hotels in Taichung.



April 14-17, 2016  
Monterey • California • USA

 SUBARU 



# HL's Drift Fork Setting Milestones

In today's competitive bike industry environment, all manufacturers are under pressure to bring truly innovative products to market that both meet and exceed customer requirements. It is from this cauldron of pressure that HL's latest fork offering, Drift, has come to fruition.

Drift is no run-of-the-mill entry level fork, the fork took 16 months to bring to market in a process which saw HL upgrade production facilities and introduce new assembly processes into their factories. Drift's steering and stanchion tubes are manufactured from aluminum 7050, giving it superior stiffness and safety, while at the same time keeping the weight down. Stiffness and weight-reduction are further enhanced by making the lower leg from a magnesium alloy.

The Drift is, of course, air- rather than coil-sprung, allowing riders to inflate to a pressure that suits them. It also includes three different dampening adjustments: rebound, compression and climb mode. These allow riders to

adjust the fork according to the course they face. Climb mode can be adjusted on-the-fly while climbing, allowing riders to not only transfer as much force as possible to the wheels, but also maintain some vibration absorption for improved comfort and stability. Additionally they have developed customized wipers and air-seals to reduce friction and give riders an even smoother ride.

With such a milestone product, HL, of course, paid much attention to aesthetics. The company referenced the dramatic 'muscle definition' of famous sports cars to give the Drift a stylish appearance that stands out amongst its competition in the crowded suspension fork market.

HL are currently introducing Drift to product managers at booths 1051, 1150 and 1151 in the Tempus hotel at Taichung Bike Week. 🇹🇼 WG



**FIRST**  
components

## Headsets Height Adjustable

- Easy Assembly With Only One Tool Without Using Mechanic Pressing
- Fits Various Head Tube Height
- 100% Concentric Cups

**FIRST Booth No.: B2, A27/28**

**Evergreen Laurel Hotel (Taichung)**

[www.firstcomponents.com](http://www.firstcomponents.com)

## Adaptor

Reduce Taper Lower 1.5" Head Tube to 1-1/8" ZS

**M49A** 49/44 **M55A** 55/44

**M56A** 56/44





**BAFANG**



# MAX drive system

Powerful. Smooth. Silent.



20-23 October 2015  
Booth No.: 1058 & 1059

[www.szbafe.com](http://www.szbafe.com)

*Your Dream, Our Goal*

# SRAM Unveils Wireless Shifting

During Eurobike this year, SRAM revealed their electronic wireless shifting groupset, Red eTap, at Eurobike. The system, which has been in development for the past five years, has been much anticipated after being seen at various pro races throughout the year.

Utilizing 128-bit encryption, eTap® shift signals are transmitted and received in accordance with SRAM's proprietary wireless protocol known as AIREA. Each time an eTap groupset is paired, a new encryption code is generated and assigned to

the components in this group to ensure complete shifting security.

SRAM have also overhauled the method of shifting to facilitate more intuitive and consistent shifting. Appropriately named eTap, Tapping the right lever shifts the rear derailleur down, while tapping the left lever makes it shift up. Tapping both levers together shifts the front derailleur.

The eTap system also utilizes SRAM's proprietary Yaw design of front derailleur cage rotation allowing the angle of the cage to rotate in order to

maintain a consistent angular relationship with the chain for ideal shifting performance in every gear combination.

eTap brake levers and derailleurs are compatible

will all SRAM 22 cranksets, chainrings, chains, mechanical brakes, and cassettes with a max cog size of 28-teeth. WG



▲ SRAM RED eTap Shifter.

▲ SRAM RED eTap RD.



▲ SRAM Battery Back.



▲ SRAM USB stick - top.



▲ SRAM RED eTap Charger.



▲ SRAM RED eTap FD.

**ASHIMA®**  
Without Limit



www.ashima.com.tw

Splendor Hotel Booth No.: 1322



ASHIMA LTD.

Add No. 176 Bao Bu Road, Bao Bu Li Changhua 50089 Taiwan R.O.C.

Tel: 886-4-7260496 Fax: 886-4-7260638

E-mail: ashima.twn@msa.hinet.net

Ashima...Knowing you're in control, means you can really let go...



# CHAORYANG®

Passion For Forward



## MERLIN 26x1.95



**New**

Blocks cross at central helps with low rolling resistance.

Base connects knobs improves table traction

S. Lite compound is the key role makes the tire's super light weight.

Dino Skin, our top anti-puncture technology, with high strength Kevlar-3 fabric inside. Tough yet light.

High density 120TPI ply casing. Decrease inner friction. Light yet strong.

Kevlar is the registered trademark for a para-aramid synthetic fiber, related to other aramids such as Nomex and Technora. Developed by Stephanie Kwolek at DuPont in 1965, this high-strength material was first commercially used in the early 1970s as a replacement for steel in racing tires.

# Huge QR Recall in US

Following Trek's April recall of nearly one million bicycles in the US and Canada due to an issue involving front wheel QR handles opening too far on disc-brake equipped bicycles and potentially making contact with the rotor, 13 other major brands in the US have voluntarily joined together under the umbrella of the BPSA to recall a further 1.5 million bicycles having the same problem.

The issue arises from certain front-wheel quick-release cam levers that, if improperly adjusted or left open while riding, can come in contact with the front-wheel disc brake rotor, potentially causing the front wheel to come to a sudden stop or separate from the bicycle, posing a risk of injury to the rider.

The Bicycle Product Suppliers Association ("BPSA") has assisted in bringing the group together and in ensuring riders and retailers are informed about the recall, and as part of its efforts, a central website ([www.quickreleaserecall.com](http://www.quickreleaserecall.com))

has been established to address questions and direct consumers and retailers to the appropriate resources.

The recall addresses bicycles that were sold equipped with disc brakes and a front quick-release lever that can come into contact with the front disc brake when improperly adjusted or left open while riding.

Riders are being instructed to check the website to see if his or her bike is part of the recall, and if so they are being advised to stop riding the bike and take their bike to a dealer to have a new quick-release installed. In many cases, the replacement can be accomplished in as little as five minutes.

"Rider safety is our top priority," said Patrick Cunnane, Chair of BPSA's committee addressing this matter. "We are pleased to be able to serve a role in bringing together the participating companies and facilitating this unprecedented large group effort."

The recall is being conducted by the 13 companies

in conjunction with the U.S. Consumer Product Safety Commission, Health Canada,

and the Consumer Protection Agency of the United Mexican States. 

### YOUR SKEWER IS FINE IF:

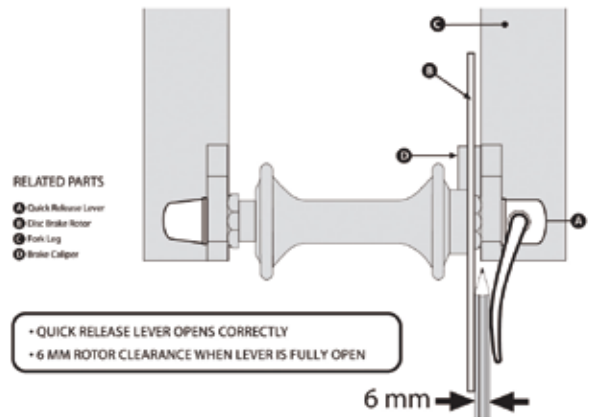

### REPLACE YOUR SKEWER IF:

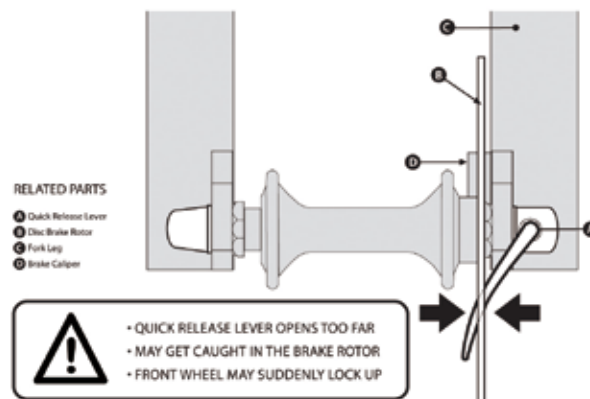

2015  
TAICHUNG BIKE WEEK  
BOOTH NO.

EVERGREEN  
RM-321



A-PRO TECH CO., LTD  
[www.apro-tek.com](http://www.apro-tek.com)  
[apro-sales@aprotek.com.tw](mailto:apro-sales@aprotek.com.tw)



ALL NEW DH650B RIM / WHEEL  
AM VERSION AVAILABLE AS WELL!!

	DH Version	AM Version
Outer Width	36.6mm	36.6mm
Inner Width	27.5mm	30.2mm
Rim Weight	520 g	460 g



HIGH TOUGHNESS RESIN SYSTEM



PARTICULAR SPOKEHOLE PATCHING



NANO ELASTOMER RESIN COMPOUND

# PRECISE CONTROL

For Mountain Bike



## Tequila Series 35mm



MTB-AL-3500BT/ISO-M

**MATERIAL:** ALLOY BUTTED

**BACK SWEEP:** 6° 10°

**FINISH:** SAND BLASTED AN BK or SILVER

**BAR BOR:**  $\varnothing 35$

**RISE:**  $\pm 5$

**COLOR:**

**WIDTH:** 720 740 760 780 800

**WEIGHT:** 292g(W:800)



MTB-AL-3512BT/ISO-M

**MATERIAL:** ALLOY BUTTED

**BACK SWEEP:** 6° 10°

**FINISH:** SAND BLASTED AN BK or SILVER

**BAR BOR:**  $\varnothing 35$

**RISE:** 12

**COLOR:**

**WIDTH:** 720 740 760 780 800

**WEIGHT:** 292g(W:800)



MTB-AL-3520BT/ISO-M

**MATERIAL:** ALLOY BUTTED

**BACK SWEEP:** 6° 10°

**FINISH:** SAND BLASTED AN BK or SILVER

**BAR BOR:**  $\varnothing 35$

**RISE:** 3

**COLOR:**

**WIDTH:** 720 740 760 780 800

**WEIGHT:** 310g(W:800)

## Tequila Series 35mm



TDS-RD605-8-35/ISO-M

**MATERIAL:** 3D FORGED ALLOY **EXT:** 40 50

**RISE:** -12° **HEIGHT:** 40

**FINISH:** SAND BLASTED AN BK or SILVER



TDS-D607-8-35/ISO-M

**MATERIAL:** 3D FORGED ALLOY **EXT:** 45 55 65

**RISE:**  $\pm 7^\circ$  **HEIGHT:** 41

**FINISH:** SAND BLASTED AN BK or SILVER



**COLOR:**



## Direct Drive THE DD STANDARD

20% MORE TORQUE  
DIRECT POWER TRANSFER  
IMPROVED STIFFNESS  
OPTIMIZED POWER TO WEIGHT  
REVOLUTION DRIVE CHAIN & HUB  
SIMPLISTIC DESIGN SOLUTION  
RELIABILITY....



Switch to  Direct Drive



Traditional  
Hub Freewheel

HUB  
FREEWHEEL  
MOVES TO  
BB



2015 Taichung Bike week:

Tempus Hotel B1/ **No. 23 & 24** (Hall A)

**TAIWAN KT**  
KUN TENG INDUSTRY CO., LTD.



www.o-lite.com.tw

E-mail: kttw@q-lai.com.tw

# Cionlli and Dow Polyurethanes Introduce Cooperative Olympic Promotion Project



▲ Cionlli Vice-President, Richie Lee (right) signs a strategic cooperation agreement with Dow Polyurethanes President, Huang Chu Lin.

The Cionlli Group has recently signed a strategic cooperation memorandum of understanding with the prominent polyurethane supplier Dow Polyurethanes in Shanghai. In accordance with this agreement, Cionlli will use the new high-tech material Specflex provided by Dow Polyurethanes in its bicycle saddles, and will sell these saddles to customers in the China, Taiwan, and Hong Kong markets.

The Cionlli Group has a total of five production sites and two marketing offices in China and Taiwan. It has long produced saddles for leading bicycle brands, and seeks to produce the most comfortable saddles using environmentally-friendly production technology. Cionlli now hopes that innovative materials from Dow Polyurethanes will provide it with a solution for high-performance saddles.

Dow Polyurethanes' Specflex foaming technology offers improved saddle performance. The light weight and excellent shock-absorbing ability of Specflex can provide cyclists with even greater comfort. In addition, the use of water as a foaming agent ensures that the production process is easier on the environment, and helps reduce energy

consumption and harmful gas emissions. This technology simultaneously takes performance, economic effectiveness, and the environment into consideration, and promises to stimulate sales of Cionlli's products.

As Dow Polyurethanes is the sole chemical engineering firm sponsoring the Olympics, and has the right to use the Olympic logo, Cionlli has teamed up with Dow to introduce a five-month Olympic tag promotion project. By using the Dow name and the Olympics rings on saddles produced employing Dow's production technology, Cionlli hopes to make customers aware of its use of technologically innovative materials and its responsibility for continuing to promote social undertakings.

Even more importantly, this collaboration will enable Cionlli and official Olympics sponsor Dow Polyurethanes to jointly promote the Olympic spirit of mutual understanding, joint participation, self-transcendence, innovative breakthroughs, and the aggressive seeking of progress. Cionlli will use the logo on products made using the new Specflex material to highlight this joint program, which will draw greater attention to the Olympic spirit. 

# RST Increase Hub Compatibility on Inverted Fork

Specializing in manufacturing all types of forks, and with over 15 years experience in inverted fork design, RST have introduced their first single crown inverted fork-Rebel.

Not only does RST's new suspension fork offer the advantage of significantly reduced weight and smoother bushings, the single crown design allows for longer travel. RST's 29-inch models offers up to 130mm, and the 27.5+ version up to 150mm of travel. RST's have also increased the fillister size on the Rebel to overcome the limited hub compatibility issue of inverted forks currently on the market. This increased size means the Rebel can be used with a wider range of hubs.

In addition to high-end inverted suspension forks, RST are continuing development of forks for cross country,



►RST have made their single crown inverted fork bigger to accept different styles of hubs.

children's bikes and have a new hydraulic seatpost model. RST are also expecting to open a US office to further increase levels of service available to customers. WG

# Bosch Upgrade eMTB Drive System

While the eMTB category may be struggling for acceptance in America, in Europe electric-powered mountain bikes are everywhere. A walk around the halls of Eurobike revealed that nearly all manufacturers are introducing new eMTB models this year. To cope with the trend, the leading e-bike drive system manufacturer, Bosch, has upgraded their Performance Line CX Drive, giving the drive system a serious performance boost with significantly higher torque and maximum assistance of up to 300%.

Bosch has taken into account the growing demand for drive systems that are used for sporting purposes over tougher terrain with the upgrade to the Performance Line CX Drive. By increasing torque from 60 to 75 Newton meters, the drive enables riders to accelerate faster and more powerfully than before at low cadences such as on steep ascents. The company claims that even starting on an uphill slope is no trouble for the updated system. The

new Line CX also features Turbo mode that provides a maximum assistance of 300%.

To ensure that the extra power reaches the rear wheel swiftly and effectively, the Performance Line CX has a shift recognition feature enabling superior timed, dynamic gear changing. For better climbing performance, manufacturers are able to fit a 14-tooth chain ring to the crank that will offer extra comfort as a "mountain gear".

Another new feature for the Performance Line CX is its new-look frame interface that enables the wheel alignment to be set even more precisely. WG



**MADE IN TAIWAN ONLY**  
**Easy and Fast ,**  
**New Concept for**  
**making**  
**Reversal !**

You don't actually need any tools to remove the driver.

**REVERSAL ENGAGED SYSTEM**



**QL-X41R**  
 Weight : 505g

# The advances in Dynamo hub technology have changed everything

The QR Dynamo System is applied to all specifications of bicycles.



**JH-KD6F**  
 Weight: 415g

**OUTPUT: 6V 3W**

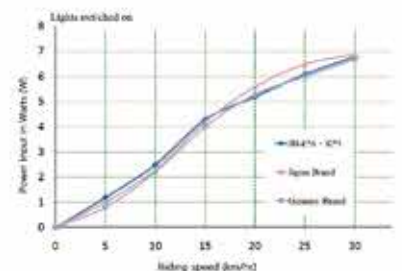

2015 Taichung Bike week:  
 Tempus Hotel B1/ **No. 23 & 24** (Hall A)

**TAIWAN KT**  
 KUN TENG INDUSTRY CO., LTD.



www.o-lite.com.tw

E-mail: kttw@q-lai.com.tw

# TranzX Antishock Components

**T**ranzX have developed an innovative new antishock stem—JD-ST129A. The patented design absorbs shock vibrations, especially uncomfortable on long rides, and helps reduce numbness and fatigue in riders hands, arms, shoulders and neck.

The integrated design offers clean and stylish aesthetics together with excellent ergonomics. Specifications of the stem include a rise angle of degrees and bar bore of 31.8 mm.

Using the same technology, TranzX have also developed the JDSP129 Antishock seatpost. Specifically designed to reduce numbness of the waist, buttocks and knees on long rides. The seatpost features an integrated design with -4~+4 degrees backward / forward displacement. 



# 80th Birthday Celebration Dinner for Cionlli President

**Y**esterday evening, October 19, 2015, Cionlli held a reception party attended by about 200 guests from the bike industry at Le Blé d'Or in Taichung. The dinner was held to thank guests for their support, and at the same time celebrate the 80th birthday of Cionlli Chairman, Ching Song Lee.

Deputy G.M of Sales, Richie Lee welcomed guests to enjoy the food and drink, and reminded everyone to take a Cionlli catalog away with them for later reading! Cionlli President, Ching Song Lee especially thanked the gathered guest for the support and endearment given to Cionlli, and told them that even after being in the bicycle industry for 53 years, he never imagined that he would see so many friends together to celebrate his birthday.

Guests shared the birthday cake prepared for President Lee on his birthday and wished him many happy returns on his birthday.

For the four days of Taichung bike Week from October 20~23 the company will be in the Evergreen Hotel, booth B2-A6 where the Cionlli and Smanie brands will be displaying their latest ranges of environmentally-friendly, heat-resistant, waterproof, lightweight and other specialty products. 



◀ Cionlli President, Ching Song Lee (fourth from right); General Manager, Daniel Lee (second from right); Deputy G.M of Sales, Richie Lee (far right) with their family industry guests.

▼ Over 200 guests from the bike industry attended to celebrate President, Ching Song Lee's 80th birthday.



1190



4090



4115

Visit us at Everygreen Hotel Booth. B2 A6



## FEATURES

- \*NEW SHAPE MAXIMIZES STRENGTH WHILE MINIMIZING WEIGHT
- \*NEW CHAINRING PINS IMPROVE SHIFTING FOR SMOOTH AND ACCURATE SHIFTS

# ROAD RACE ETERNAL-721C-TT

- .Crank Length: 170,172.5,175mm
- .Crank Material: Forged AL-6061-T6
- .Crank Finish: HP Black Ano.
- .Chainring: 52-36T/50-34T
- .Chainring Material: AL-7075-T6
- .Chainring Finish: 100% CNC Mach., Black Sand Ano.
- .Compatibility: 11S
- .Chainline: 43.5mm
- .BCD: 110mm
- .Q/I-factor: 160/129mm
- .Weight: 946g  
(50-34T,170mm)



PW-BB68+  
INTEGRATED TT ROAD-II



PW-BB86  
BB86

**PROWHEEL**  
WWW.PRO-WHEEL.COM

Whole Man Enterprise (Taiwan) Co.,Ltd.  
NO.47,Beicheng Road,North District,Tainan,  
Taiwan(R.O.C.)  
Tel:886-6-2825791/92  
Fax:886-6-2825746  
E-mail:prowheel@ms13.hinet.net  
sales-tw@pro-wheel.com

Haomeng Bicycle (Shanghai) Co.,Ltd.  
8553 Chuannanfeng Road,Situan Town,  
Fengxian District,Shanghai,China.  
Tel:86-21-57532846/47  
Fax:86-21-57536961  
E-mail:sales-sh@pro-wheel.com

Whole Man Enterprise (Tianjin) Co.,Ltd.  
NO.8 Xinmin Road,West area,Developing Zone,  
Tianjin,China.  
Tel:86-22-66321818  
Fax:86-22-66321819  
E-mail:sales-tj@pro-wheel.com

# 2015 Kielce Bike-Expo

Poland's Kielce Bike-Expo attracted 200 participating firms this year, and occupied five exhibition rooms. The leading manufacturers were spread out among the five rooms; 11 companies from Taiwan and more than 20 companies from China were present.

Poland's bicycle industry shares a similar culture with its counterpart in Taiwan, and its members maintain relationships characterized by both rivalry and collaboration. Since Jan Zasada took over as director, the Bike-Expo has been well-run, and both manufacturers and participating firms have expressed positive opinions. The vast majority of firms also



▲Zasada President, Jan Zasada is also the chairman of Poland's bicycle association. Zasada produces 70,000 bicycles a year.



▲Romet President, Wieslaw Grzyb. Romet produce 400,000 bicycles a year.



▲Unibike Commercial Director, Zbigniew Lewandowski. Unibike produces 40,000 bicycles a year and is also a distributor for component brands such as Schwalbe.

feel optimistic about 2016, and believe that the market will continue to grow. Major

manufacturers represented at the show included Kross, Romet, Unibike, Zasada and Fuji. In addition, a small number of parts manufacturers were present, including the state-run brand, SIHD. Also in attendance were Czech and Slovakian brands Author, Kellys, 4ever, Bikefun, Dema and Sundance. Agents included Aliot and Polbike. While a large majority of people at the show spoke Polish, most could communicate adequately in English.

Ravaged by war, Poland has gradually achieved stability through much long-term effort. It is very representative of the Eastern European country, and

is a member of the European Union. With a population of 38.4 million, Poland is well-integrated economically with the EU, but still uses its own currency (the zloty). As a result, Poland has emerged relatively unscathed from the recent depreciation of the euro, or has hedged using dollars. As a result, the Polish bicycle market has enjoyed steady growth.

Poland is the third largest bike manufacturer in the European Union, and has an annual output of around one million bikes. The country's annual bicycle sales total roughly 1-1.1 million units. Cycling is becoming a nearly universal

**Yu Hub Industrial Co., Ltd**  
No. 17-17, Lun Tzy Jairo Rd., Ding Juang, Shi Hwu Chang Hua, 51448, Taiwan  
TEL: +886-4-8811738  
FAX: +886-4-8812386  
Email: Info@wheelmate.com.tw

www.yuhub.com.tw



▲Brat-Pol was founded by two brothers. President, Wikior Beska (right) and General Manager, Karol Beska (left). Brat-Pol produce 20,000 bikes a year.



▲Aliot President, Jacek Batkowski; Kenda's distributor in Poland.



▲Piotr Witeska is the agent for CST, Maxxis and Merida in Poland.



▲Polbike President, Piotr Malkowski. As well as having their own brand, Saveno; Polbike are also the distributor for Raleigh.

activity in Poland, and numerous brands consider the country to be a key market. Polish workers have monthly salaries of around 600 euros. Many Western European companies rely on OEM production in Poland. The people of Poland

are serious workers and are good at negotiation. Since most Poles have limited disposable incomes, most bicycles sold here are low-/mid-priced models, and commuter bikes and children's bicycles enjoy especially good sales. While the

market for second-hand bikes is still quite large, previously accounting for 40% of the market, it now represents only 25%. In recent years, sporting and recreational bikes have begun growing in popularity. Prices vary depending on the

positioning of each bike shop; children's bikes cost from 60 to 220 euros. Recreational e-bikes and fat tire bikes were each displayed by several firms at the show, but their relatively high prices have discouraged widespread adoption. 🌐WG

## 2015 Formosa 900

In November of this year, the annual cycling tour of Taiwan, the Formosa 900, will once again set off on its 9-day tour covering 900 kilometers in a circuit of Taiwan. In the past the event, organized by the Taiwan Bicycle Exporters Association, has attracted numerous members of both the Taiwanese and international cycling industry, as well as diplomats, cycling personalities and disabled cyclists.

The 2015 event will see 19 groups of riders departing from different locations all over Taiwan on Saturday, November 14 as part of the Taiwan Cycling Festival. Riders cycle around Taiwan and get the chance to experience the beautiful scenery that led to the Portuguese naming the island 'Beautiful

Island' in the 16th century. Along the way, cyclists will also be introduced to various attractions, both man-made and natural, as well as experience local cuisine, Taiwan's rich native culture and friendly people.

The Formosa 900 offers product managers and other members of the international community a chance to see Taiwan away from the industrial heartland where they usually visit for business reasons, At the same time it also provides a wonderful opportunity to network with other members of the industry in a relaxing and invigorating environment. 🌐WG



▲ Kenda Chairman, Ying-Ming Yang with Kenda Group riders pause at the Hsi Luo bridge.



▲ Riders on the Formosa 900 enjoy the spectacular scenery of 'Mr. Brown Boulevard'.

# 2015 Cosmo Bike Show Indicates Upturning European Markets

A move to the historical city of Verona set the tone for Cosmo Bike Show, southern Europe's most important bicycle show, this year. Spread of over four halls, the event managed to attract international exhibitors from countries such as Bulgaria, China and Taiwan. Although the show mainly attracts local vendors, the size of the market together with Italy's high bicycle production output, give the exhibition important status in Europe.

Bianchi, Colnago and De Rosa were among the many Italian brands exhibiting at the show. Also attending were 96 exhibitors from Bulgaria, including Mascom and Leader. Eight manufacturers from Taiwan also made an appearance, and the 16 companies from China, showed that at least some Chinese manufacturers still have active ambitions to expand in Europe. Most manufacturers attested to the continued recovery of the Italian economy, and after seeing show

crowds increase day by day, also said they would participate in Cosmo Bike again next year. While some vendors found the booth aisles to be very narrow, some carpet missing, or were not particularly satisfied with some hardware parts, they still affirmed the importance of the exhibition, which the organizers promised to improve by making the hardware and software more perfect.

As the European bicycle industry base, bicycle production in Italy is not only the highest in the European Union, the market is also considerable. Apart from Italy's road racing bike brands, which are the envy of the world, bicycle clothing, shoes, saddles and other parts with a large market share, faced economic downturn caused by delayed orders and other issues a few years ago. This year the economy is gradually stabilizing, and although some manufacturers are still facing financial difficulties, Italy is very indicative of the European market.



▲ITM President, Jack Craciun III.



▲Bottechia CEO, Diego Turato (left) with GM, Morco Sguotti (right) and their Taiwan agent, Forderland, President Jimmy Chang.

This year's exhibition was held in the classical city of Verona, a city rich in culture and history, and the setting for Shakespeare's Romeo and Juliet. The exhibition center plays host to many other world-class expositions such as a marble, wine and olive oil exhibitions. It is also located conveniently close to the city, so that vendors staying in the old city can learn more about the market culture and only need to face a 5-minute drive to the exhibition center. 🌐WG



▲Many fat tire bikes at Cosmo Bike Show featured CST tires.



► Campagnolo has wheelset production in Romania.

**SAMOX**

Taichung Bike Week booth# **RM319**

www.samox.com.tw

DIRECT MOUNT

**BOOST 148**



**NARROW WIDE TEETH**  
CNC/Alloy Forged /Steel Forged Ring

**E-BIKE**

for E-Fat Bike



# Velo Bring Tomorrow's Technology to Today's Products

**P**remier Taiwanese saddle manufacturer, Velo, are no strangers to designing and manufacturing products that are ahead of the curve, This year proves to be no exception as they present their latest innovative designs at TBW.

## E-bike saddles

Velo have been concentrating much energy on saddles designed for all types of e-Bikes, including MTB, City and Touring e-Bike. Focusing on bringing the utmost in comfort to these saddles, Velo have developed three new patented technologies that they are incorporating into their entire e-bike saddle range.

Double Density™ is a dual material used in the base of the saddle offering riders flexible support and thus, greater comfort. Arctech™ is a rail mounting suspension system that provides superior shock absorption. The U-Carry™ design is a system handle under the seat which giving riders an easy and convenient handling solution.

Furthermore, they take the best quality shock-absorbing foam, the optimal sizing for different types of e-Bikes, and a sleek appearance to develop a superb E-Bike saddle.

## The Angel Line



Velo have also launched a new range of saddles aimed specifically at professional racers and performance minded road cycling enthusiasts—The Angel Line. These saddles feature a patented Y-shaped cut-out in the shell which, operating in conjunction with gels and the innovative Arctech™ rail mounting system, allow for optimal pressure and weight distribution, giving the competition seat an unsurpassed level of comfort while still remaining extremely lightweight. The Angel line is available in four versions, including a 115 gram carbon version—Angel Glide, a thin-padded version—Angel Dive, a thick-padded version—Angel Fly and a 144mm wide version—Angel Ride.



## Silicon grip / Handlebar tape

Not content to let innovation rest its saddles, Velo has introduced a new silicone foam material in both its handlebar tapes and grip lines. Silicone is one of the most environmental friendly materials for these applications. It increases durability over other offerings while delivering the requisite non-slip performance and lightness that riders demand. It also provides excellent shock-absorbing feature, which reduces fatigue for the riders. Velo's handlebar tapes made of silicone hold in place without the need a

of traditional adhesive strip, allowing easy removal and replacement with no glue residue on the handlebars.

During Taichung Bike Week, Velo are displaying their latest range of products at The Tempus Hotel's Holland room.

WG





[www.necoparts.com](http://www.necoparts.com)

全球首發 全球專利

**Debuting Universally  
Worldwide Patented**

PAT. CN: 3884861 / 4118628 TW: M487876 / M497135

The world's most tidiest semi-integrated headset  
隱藏式內走線 車頭碗組



**NECO 1**

NECO 1 圖示，不佔空間

USE NECO 1

NO NECO 1 傳統組裝



**NECO 3**

PAT. TW: M326914 / MS09473 DE: 20 2015 104 197 CN: 201520350512.0

First smart-headset in the world  
全球首創 行動電源 智能碗組

**THE SPLENDOR HOTEL  
ROOM#1123  
金典酒店**

For CHARGE 3000mA



E-mail: [neco@necoparts.com](mailto:neco@necoparts.com)  
Neco Technology Industry Co. LTD (Taiwan R&D base)

## Full Reach's Ultra-Lightweight One-Piece Hub

Hub manufacturers are constantly working to reduce the weight of their products while enhancing tolerance, Full Reach's new product--Direct Drive (DD) escapes this thinking structure, and they are presenting the breakthrough patented design at TBW. The system moves the ratchet from the rear hub to the bottom bracket, allowing the hub to have a very simple one-piece structure and significantly reduces the weight to an ultra-lightweight 165g in addition to increasing the cranks' pedaling response speed. The use of 7075 aluminum in the single-piece hub design significantly



▲ Direct Drive moves the rear hub ratchet to the bottom bracket, allowing the hub body weight to be significantly reduced.

enhances the structural rigidity and give it an have an overall higher tolerance, a big advantage for disc brake bikes which demand more endurance.

Kun Teng has been exclusively authorized by Full Reach to develop and manufacture Direct Drive. Kun Teng General Manager Hubert Chen indicated that through the patented technology developed with the hub system, the costs will be substantially decreased, and it will certainly be very competitive in future markets. Ken Tung group will also assist in the future development of more products with Full Reach.



◀ Ken Tung General Manager, Hubert Chen (right) will cooperate with Full Reach General Manager Derek Liao, in the future to develop even more competitive products.

## Kenda Cup Getaway Ride Attracts 2000 riders

Tire manufacturer, Kenda Tires has been putting a lot of effort into promoting cycling in Taiwan. After holding the Wuling Mountain Climbing Competition in August, in October, the company held the 5th 'Bicycle Getaway Ride' in Central Nantou's Chung Hsin Township. The event managed to attract over 2000 riders.

Speaking at the event, Kenda Chairman, Ying-Ming Yang said that Kenda Cup Getaway rides had been held in Chang Hua several times, and this year moved Chung Hsin Township as it offered such a good venue with its excellent cycling routes. The Chairman also expressed his hope that all participants enjoyed the ride, and that by holding rides such as this, both cycling culture and the bicycle industry in Taiwan could continue to flourish.



▲ Kenda Chairman, Ying-Ming Yang; Vice-Chairman, Jimmy Yang and Deputy General Manager, Samuel Chen led the riders out at the departure.

CHINA LANXI WHEEL TOP CYCLE INDUSTRIES LIMITED

兰溪轮峰车料有限公司

 **WHEEL TOP**

摊位号：#1050 台中金典酒店

酒店地址：台中市西区健行路1049号

Hotel address：No.1049, chien-hsing Rd., Taichuang



Fax: +86(579)88230111 88230678  
E-mail: sales@wheeltop.com  
网址: www.wheeltop.com  
地址: 中国浙江省兰溪市城郊西路22号

 GIANT

 TREK

 DECATHLON  
迪卡侬

 MERIDA

 AIIWA 爱玛

## New Products 2016

### Ashima

#### Flotor ARF-1-160-XX

Ashima's Floating rotor is their lightweight floating disc brake rotor featuring 0.3mm of float. The float helps with modulation and the feel of the braking system. It also allows for better heat management, decreasing the likelihood of a warped rotor or a series of other heat related issues. The stainless steel braking surface works very well in both power and modulation. The alloy carrier is a lightweight solution and has higher heat dissipation capabilities when compared to the stainless steel used on other rotors.

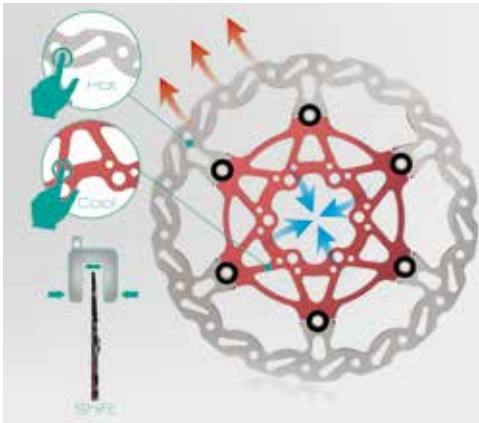

Splendor  
Booth 1322

### Modz Cycle

#### Modz H7tb

The H7tb from Modz is a foldable children's bike that is easy to lock and secure. The dimensions are 72 x 39.5 x 51cm (42x39.5x58.5cm folded). The H7tb weighs just 7.4 pounds (3.4kg) and has a carrying load capacity of 44.09 pounds (20kg). The children's bike is suitable for ages from 2 to 4-years-old.



### ManDai Aluminum Co., Ltd

#### CFF02

Just as a firefly produces light at night to make itself attractive, so too, does ManDai Aluminum's innovative new rear carrier. The CFF02 has two lights illuminating in separate directions, one downwards and the other towards the rear. The light tube may also be removed for other uses such as bicycle repairs, camping, or any other application where light is needed. The Firefly Carrier is attached to the seat tube allowing installation on numerous frame types and sizes.



Splendor  
Booth 1304

### Baradine

#### 469

The 469 brake pads from Baradine have been specifically developed for use with carbon rims. At 55mm long the pads feature a special design that quickly drives water away from the braking surface, and cleans away any crud. The pads are compatible with road brake cartridge holders.



Splendor  
Booth 1032

### Kind Shock

#### Southpaw -C

Like Kind Shock's KG remotes, the Southpaw paved the way for dropper remotes dedicated to 1x drivetrains. Heavily copied but never replicated, Southpaw quickly became the defacto underbar dropper remote with exquisite looks and ergonomics. Enter the Southpaw C. Sold as an accessory only, the Southpaw C uses an innovative split clamp allowing for 4-axes of adjustment for perfect ergonomics and feel as well as a molded UD carbon paddle for those riders that demand simply the best.



Tempus  
5F / America room

### Fulchee Ent Co., Ltd

#### F04-10 (Anti-Theft Nut)

Although quick releases offer cyclists a fast and easy way to install and remove wheels from bicycle frames, they also unintentionally increase the risk of wheel or frame theft. Fulchee's QR features an anti-theft design on the nut end to not only keep the convenient feature of bicycle quick release but also to prevent thieves from removing wheels from the frames using common tools that could be easily found in the market. It weighs in at 164 grams.



## New Products 2016

**Samox**

### R5 Crankset

SAMOX has launched its R5 series of cranksets for road bikes. The arms are hollow-forged alloys while the chainrings are monocoque full CNC chainring. The outer chainring is 8mm thick and made from AL7075 material to increase stiffness and give excellent performance. The crankset interfaces with direct-mount designs and is compatible with BB30 & PF30 bottom brackets. Options are available for a single narrow-wide chainring and a 24mm spindle system. It is available in 53-39/52-36/50-34/46-34T, etc. There is also a single narrow-wide chainring option.



Evergreen  
3F RM-319

**Innova Rubber Co., Ltd.**

### Transformers II (IB-3003N)

The Innova's latest Transformer II tire create an eye-catching design that would fit well with any aggressive-looking bike. The tire features small lines insert into each knob to give the tire powerful performance while riding.



Splendor  
Pearl Room (15th Floor)

**Hafny Co., Ltd.**

### Road Mirrors

Hafny's superior quality bike mirrors utilize Japanese-made stainless steel lenses allowing riders to clearly see behind them. The frame is made from high impact resistant nylon so that even with rugged use the mirror will not break. This material also has the advantage of decreasing mirror shake from road vibration. The mirror features an open-style clamping system making it easy to install on nearly every type of bicycle.

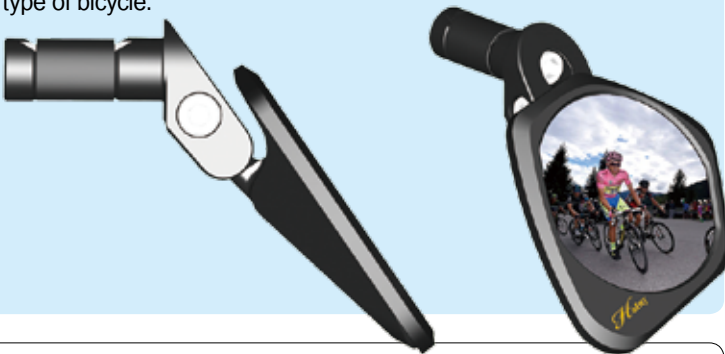

**Dosun**

### ES150

Dosun's ES150 has been designed with the intention of offering a good value and high quality bike light for riders. A delicate outward appearance of plastic which shows that the quality of products is always the first priority of Dosun, the ES150's shape is both exquisite and streamlined. The 150 Lumens illumination and special lighting pattern design will ensure riding in the dark is a joy for every rider.



**Kenda**

### Saber (K1174)

The Saber is the first of a new generation of XC tires from Kenda. Designed to be the fastest and lightest XC tire on the market. The heart of this new race-bred tire is the R3C rubber compound which allows for very low rolling resistance, amazing grip and a lightweight low profile tread design. The Saber has a high volume casing to absorb the course while a low uniform tread profile offers minimal rolling resistance; with edge knobs that are larger and hooked to give riders maximum traction in the corners.



**Apex Products Co., Ltd.**

### Taylor T-316 Frame Bag (Luggage Carrier)

Apex' new T-316 frame bags are made from leather and cotton canvas and are designed for use with a luggage carrier. The bags are available in either Chocolate, Khaki or black colors and the dimensions are 11" x 7 3/4" x 4" (28cm x 20cm x 10cm).



Splendor  
Booth 1315



## New Products 2016

**Kind Shock**  
**Zeta**

**Tempus**  
5F / America room

Zeta is the latest dropper post from KS that advances into new territory when it comes to dropper posts. Traditionally an indispensable tool used by Enduro riders, with the Zeta, KS brings a viable, high-performance dropper seatpost to the XC and Cyclocross segments.

Unlike other droppers, Zeta is always fully installed down the collar into the frame. Once seat height is established, the hollow alloy stanchion is cut to size and the over-mast seat clamp is installed much like integrated masts found on high performance road and XC framesets. The Zeta is available with either 35 or 50mm of travel.



**Step Solution**  
**27.5 Plus Rim**

**Splendor**  
Booth 1317

Step solution are introducing their state-of-the-art single wall rim with aerospace foam technology at its core. Designed to allow the 29er rider to run 27.5+ on their current bike. The rim features a composite impact layer throughout the bead and rim bed to distribute impact energy. The aerospace foam core (patented process) adds stiffness and dampening qualities. Dimensions are 43mm OD, 36mm ID.



**iLumenox**  
**Siren E-Bike Carrier Light / SS-L313E series**

**Evergreen**  
A22

The Siren E-Bike Carrier Light from iLumenox is designed with a simple yet stylish European style. The neat and slim exterior makes it suitable for almost all kind of carriers. The Siren, which has passed StVZO regulations, uses light pipe technology to provide an extra bright and wide-angled illumination area. The embedded pantoscopic reflector, which is also approved by StVZO, is an added safety touch. The Siren E-Bike Carrier Light was originally powered by a 5V DC input from a Vega E-Bike headlight, but now there are different versions compatible with a 6V or 36V E-bike batteries.



**Prowheel**  
**Eternal-721C-TT**

**Tempus**  
Booth A-B1F-A Hall-12, 13

Prowheel's latest crankset has a new shape specifically designed to maximize strength while minimizing weight. Additionally, new pins also improve shifting performance to give riders smooth and accurate shifts. The 11S chainrings are an anodized black 7075 alloy with 52-32T and 50-34T options available. The crankarms are available in lengths of 170, 172.5 and



**KMC**  
**X-eBike Series**

KMC has launched the upgraded X-eBike Series, which has 150% upgraded in chain roller hardness and 66% in pin hardness, to improve the wear resistance of X-eBike Series chains. The latest X-eBike Series chains are recommended for Bosch systems and other motors with 850W nominal power output and 120NM motor torque.



**True East**  
**B11047 (Smart Phone Holder)**

True East smart phone holder has a transparent touch screen, is 100% water resistant and a quick-click system. The B11047 is 4-14" and can be turned to either left or right, as well as up or down.



## New Products 2016

### Dosun

#### ES500 & ES700

A new, professional bike light of 700 lumens, the dual lens design and wide range illumination from these Dosun lights provide superior great illumination and safety for off-road riders.

An upper LED with a focused light beam increases the view distance, while a lower LED has a wider light beam for more safety. The compact design, light body and stable bracket ensure that these lights remain rock-solid on the handle bar when riding on either trails or pavement.



Evergreen  
A11

### iLumenox

#### VEGA E-Bike Headlight / SS-L125E series

Compared to other headlights which pass StVZO regulations, iLumenox' Vega E-Bike headlight is smaller without compromises on performance. Equipped with a super bright CREE LED, the Vega E-Bike has a light output of 35 lux. An aluminum cap helps to radiate heat more quickly without decreasing the efficiency and lifetime of the LED. The Vega E-Bike supports nearly all types of batteries from 6V to 60V, including all Bosch systems, Shimano Steps system and Panasonic batteries. A reflector can also be optionally installed to provide exceptional safety. The Vega E-Bike can also supply 5V DC output for the Siren E-Bike Carrier Light or other devices.



### Cionlli

#### McSelle

Cionlli are introducing a new range of saddles for children's bikes—McSelle. Manufactured with non-toxic materials to be both waterproof and abrasion-resistant, the saddles feature a handle design at the rear of the bike, allowing young riders to have a safer riding experience. The saddles are perfect for use on bikes from 10 to 20 inches.



Evergreen  
B2, A6

### Yu Hub

#### BR-02R

Yu Hub's BR-02R is a rear hub for BMX racing bikes, with the hub's driver system featuring 72 clicks and 6 pawls for faster engagement and to make sure the time at the gap starting point can be handled. The specifications for the BR-02R are M10\*36H\*110W (bolt type) and the flange PCD is 58 and 45mm. The hub also features sealed bearings for a 4 piece, Shimano alloy cassette with 16 tooth cog.



Tempus  
Building A B1 A Hall 9-10

### Aclass

#### CXD4

Disc brakes are the new standard in performance for road and cross bikes, and the new Aclass CXD4 is a new standard in high performance disc wheels. Featuring a tubeless ready design with 4 sealed bearings and a high engagement hub design, these wheels will provide riders with the performance they need.



Evergreen  
C1 & C2

### RST Greenergy

#### Elev8 H Seatpost

RST's Elev\* post uses forged pieces for both the upper and lower tubes, together with a needle bearing system to prevent the fork from developing side to side play while also maintaining friction free movement. The post features a light-weight, easy to adjust, two bolt rocker head. It is available in both stealth and external cable routing versions. The external cable version uses RST's PiggyBack cable entry point to avoid sagging cable when the seat is lowered. With the post sliding on needle-bearings, it will need little maintenance.

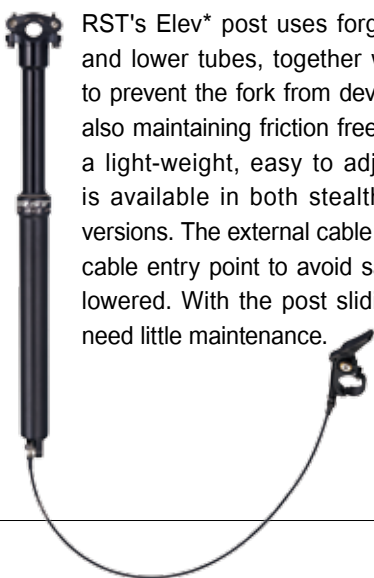

Tempus  
Canada Room

# National Taichung Theater Opens

**A** labor of love two decades in the making, the newly-opened National Taichung Theater (NTT), which is located in a commercial district in Taichung City, carries high expectations from local art communities. As a new cradle for the performing arts in Taiwan, the NTT will serve as the only national-level performing arts center in central Taiwan, and seeks to bring programs of quality and diversity from all over the world, leading to a new and positive impact on local artists and audiences.

The National Taichung Theater will be the first national-

level performing arts venue in central Taiwan. Designed by the Pritzker-winning architect Toyo Ito and hailed by Reuters as one of the world's nine new landmarks, it will house three world-class theaters: a 2014-seat Grand Theater, an 800-seat Playhouse Theater, and a 200-seat Black Box. The architecture, which is supported solely by curved walls and no pillars, exemplifies the endeavor: to engage and connect, to embrace the flow of ideas, and be unafraid to defy the norm. The structure, which also features a scenic Sky Garden, along with the Corner Salon, gift shops, cafés and restaurants,

brings about a cohesive whole that immerses and inspires. With plans in place to host biannual festivals, create local arts programs, and participate in international collaborations, the NTT will shine a light on Taichung city on this world stage, and let the appreciation of art become a way of life.

"The National Taichung Theater is not just a building that

houses the opera. The entire architecture itself is an opera," enthuses designer, Toyo Ito. "One can feel the flow of air, sound and light not only in the foyer, but within the restaurant, sky garden and everywhere else in the building. One feels overwhelmed by the grandeur of a cosmic brilliance coming out of the architecture."



▲ "The entire architecture itself is an opera." - NTT Designer, Toyo Ito.



▲ The National Taichung theater & iBikes are just two facets of Taichung's changing environment.



www.aiclass-wheels.com





**CPD4**

SUPER LIGHT, TUBULAR READY, ROAD DISC AND CYCLOCROSS WHEELSET

BOOTH C1/C2

# Taipei Set for Velo-City

For the first time in its 35-year history, Velo-City, the annual series of conferences aimed at bringing together all those involved in policy, promotion and the provision of cycling facilities, is coming to Taipei. It is also the first time the event has been held in Asia.

Velo-City 2016 in Taipei will explore the profound impact of the evolution of cycling from five different angles: Urban Transitions, Moving Lifestyles, Sustainable Economics, sharing Societies, and Design in Motion. The subjects have been chosen to reflect the way the shift from motorized individual transport to walking, cycling, and public transport has significantly influenced the way we live in the environment, the cities, and society as a whole.

### Confirmed Keynote Speakers

As of September 21, 2015 confirmed keynote speakers at the conference include UCLG-ASPAC Secretary General, Irawati Tjandradewi; President of Trek Bicycle, John Burke; Chair Committee on Transport and Tourism for the European Parliament, Michael Cramer; Secretary General of World Federation of the Sporting Goods Industry (WFSGI),

Robbert de Kock; CEO of Giant Bicycles Tony Lo; President of KMC Chian Industrial, Robert Wu and CEO of Hangzhou Public Bicycle Service, Xuejun Tao.

### Cycling Tours

Velo-city 2016 will also feature eight half day tours designed to give participants an insight into the incredibly diverse city of Taipei in a relaxed and casual way during the Velo-city conference.

Each tour will be a leisurely 20-30Km, With water and snacks are provided. At the same time, there will be staff on hand to help capture the beautiful memories you will undoubtedly acquire. This year, be it on a bike, a ferry, or the MRT, we recommend you choose at least one tour and let us take you to see the magnificent city of Taipei from a different angle and enrich your Velo-city Taipei experience.

Every tour will be led by a professional cycling tour guide not only to ensure the safety of the participants but also to give a detailed introduction of each destination. Each tour will have its own unique theme, including architecture, culture and art, historical sites, nature and ecology, geographical environment, history, geology,



▲Taipei city's Youbike public bike-sharing scheme boasts the world's top usage rate and its success has attracted much international acclaim.

and special street foods. Themes for the tours include: Trekking into History, Back in Time, Winter Warmth, Ferrying around Taipei, Feast on Culture, Loving the Blue, Boulevard of Art & Philosophy and Riverside Blossoms.

### Technical Visits

Held on February 26, 2016, this full-day technical tour will head to Taichung City and visit top-notch bicycle manufacturers Giant and VP Components Co.. Visitors will also explore the Cycling & Health Tech Industry R&D Center before entering the

"Iron Hill Cycling Sport Village". Equipped with a UCI-standard bicycle sports facility, the multifunctional neighborhood is designed to promote the cycling culture and establish a model for a healthy lifestyle. UWG



VELO-CITY GLOBAL 2016  
EVOLUTION OF CYCLING  
FEB 27-MAR 1 TAIPEI, TAIWAN  
www.velo-city2016.com

Theme		Sustainable Urban Development	Sharing and Life style	Industry	Design of Infrastructure and Products	
Data	Day 0 (2/26)	Day 1 (2/27)	Day 2 (2/28)	Day 3 (2/29)	Day 4 (3/2)	
Morning	Cfc ( Cities for Cyclists) / S4C ( Scientists for Cycling)	Opening Ceremony	Plenary 2	Plenary 3	Plenary 6	
		Coffee Break				
Afternoon		Sossion 1-5	Sub Plenary 1-3	Sossion 16-20	Sossion 26-28	Sub Plenary 4 Design exhibition-Prize winner
		Lunch Break	Bike Parade	Lunch Break		
		Sossion 6-10		Plenary 4	Closing Ceremony / Hanover Ceremony	
		Coffee Break		Coffee Break		
		Sossion 11-15		Sossion 21-25		
Evening	City Hall Reception	Plenary 1	Plenary 5			
		Welcome Reception		Gala Dinner		



▲Under the auspices of ECF President, Manfred Neun (center), Taipei Deputy Mayor, Chou Li-fang (left) receives the Velo-City emblem from Mayor of Nantes--the host city in 2015, Johanna Molland (right).

# International Dining in Taichung

International visitors to Taichung's Bike Week will be able to find an almost endless variety of local Taiwanese cuisines to sample, most of which are excellent, and some of which are, frankly, bizarre. However, there may come a time when one may wish to taste something from home, or to sample meals from other exotic locations. If this is the case, Taichung has you covered. Some of the following restaurants may be just what you need.

## Chillies Indian Restaurant

This Indian restaurant is very popular, both with locals and foreign visitors, due to its tasty and authentic cuisine. They have a large number of dishes available, both vegetarian and non-vegetarian, to fit all your dining needs. In addition, it is located in a very nice area, situated quite close to the Fine Arts Museum in Taichung. While it is not inexpensive by Taichung standards, it is well worth the trip.



📍 No. 47 Chunzhong Street, West District, Taichung  
 ☎ +886 4 2377 0007  
 🌐 [www.facebook.com/CIRTaichung#\\_=\\_](http://www.facebook.com/CIRTaichung#_=_)

## Le Moût Restaurant

The menu at this beautiful restaurant speaks with an impeccable French accent, thanks to the dedication and experience of chef-patron Lanshu Chen. She trained at school Ferrandi in Paris and worked in restaurants under leading French chefs such as Jean-François Piège, Jérôme Chaucesse and Patrick Pignol. A stint at Thomas Keller's The French Laundry followed, before she set up her own restaurant in the heart of Taichung in 2008.



📍 No. 59, Cunzhong St, West District, Taichung  
 ☎ +886 4 2375 3002  
 🌐 [www.lemout.com](http://www.lemout.com)

## Pizza Rock Tai Chung

Run by Canadian Italian Ugo Ortolano and his Taiwanese wife Ruby, Pizza Rock boasts authentic Italian pizza in the heart of Taiwan. Called by some "the best pizza in Taichung", the cooks use the best ingredients possible to produce pizza like few others in Taiwan. No green pea or corn toppings here. They also serve quite delicious paninis and baked pasta dishes, if those are more to your taste.



📍 202 Jing Cheng Road, Taichung  
 ☎ +886 4 2310-0228  
 🌐 [www.pizzarock.com.tw](http://www.pizzarock.com.tw)

## Mister India

Receiving very good reviews by almost every food website, Mister India is a small, cozy restaurant with a friendly, attentive staff. Specializing in curry dishes, owner Jagjit Singh wants all his patrons to have a full Indian meal experience. The food here is fresh, tasty, and of an exceptionally high quality. The owner has been known to give discounts to customers for no reason at all, other than he enjoys their company. An excellent value for your money.



📍 No. 6 Jingchen Road, Xitun District, Taichung  
 ☎ +886 4 2320 8821

## La Fete French Restaurant

This is a more high-end kind of restaurant, with meal prices reflecting that status. That, in addition to the rather limited selections in meals, tends to make this establishment somewhat more specialized. The food they serve is uniformly excellent, but don't expect a wide choice. The décor and ambiance are right out of a European bistro, and the service is quite friendly. Recommended for the more adventurous traveler.

📍 No.587 Huiwen Road, Nantun District, Taichung  
 ☎ +886 4 2252 1680  
 🌐 [www.lafete.com.tw](http://www.lafete.com.tw)



追求极限,质量保证



- 展會地點: 台中金典酒店 (The Splendor Hotel Taichung)
- 攤位號碼: 10F(1048)



JINHUA STARS ALLOY RIMS CO.,LTD

ADD: Hanxiang Jindong Jinhua Zhejiang China TEL: 0086-579-82863555 82862899 82862679  
FAX: 0086-579-82863908 P.C: 321032 E-mail: stars@stars-rim.com

www.stars-rim.com

NUTT JAK

To be with you al the way.  
WE HAVE BETTER DISC BRAKES

2015 台中金典酒店  
The Splendor Hotel Taichung  
booth no. 1206



S-1



S-3



Y-1



T-1



ER-1

兰溪市捷克运动器材制造有限公司

LANXI JIEKE SPORTS APPARATUS MANUFACTURING CO.,LTD

地址: 浙江省兰溪市筑路路123号 Address: NO.123, Kaixuan Road, Lanxi, Zhejiang, China  
邮编/Zip: 321100 电话/Tel: +86 579 88948936 88988019 传真/Fax: +86 579 88988075  
Http://www.discbrake.cn E-MAIL: chinayake@126.com



SHOW DAILY Publisher

A&G

President & Publisher: Grace S. Ruan

Vice President: Jerry Wu

Editorial Director: Daphne Chen

Translation Editors: Glen Lucas, Robert Hornsey

Chief Editor: Bred Wu

Associate Managing Editor: Sony Chang

Editorial Captain: Saya Wu

Digital Publishing Dept. Captain: Stan Hsu

Editorial Department: Chuang-wei Liao, Ned Wu, Leon Wu,  
Yung Jen Lee, Alfred Tsai, Wayne Huang

Editorial Assistant: Ping Chou, Hsiang Chieh Wang

Digital Publishing Dept. Captain: Stan Hsu

Art Designer: Jin, Jessica Lin, Tia Yu

Advertising: Joey Huang, Davy Lin, Rick Lin, Tom Lai, Melody Hsu, Scott Chiu,  
Kevin Wu, Tyler Wu

Secretary: Jean Huang

Administration: Angela Chen, Emily Chen, Trina Ke, Eching Hsieh,  
Jonathan Wang, Catherine Chen

Computer Center: Robert Lin

Website: <http://www.biketaiwan.com>

E-mail: [rep@mail.wheelgiant.com.tw](mailto:rep@mail.wheelgiant.com.tw)

Head Office: 193 Tze-Chiang Rd., Changhua City 50095, Taiwan

Tel: 886-4-7350500, 7360794~5

Sales Dept Fax: 886-4-7357860 Editorial Dept Fax: 886-4-7360789

Taipei Branch Office: 7F., #80, Fushing North Rd., Taipei, Taiwan

Tel: 886-2-27522477, 27400737 Fax: 886-2-27733028

Advertising: Pelin L. Lee

Shanghai Branch Office: Room 1802 Building 2, No. 999, Bailu South Road,  
Kunshan District, Jiangsu, China.. Postal Code: 215500

Tel: 86-512-57515789, 86-512-57516309 Fax: 86-512-57515789-8899

Tianjin Branch Office: Room 3406, Unit 1, Building 17, Merchants Diamond  
Hills, Olympic Sports Center East, Weijin South Road, Nankai District, Tianjin,  
China

Tel/Fax: 86-22-28137969

Shenzhen Branch Office: Room 2230-2231 Jin Xiu Jiangnan,  
Meilung Rd., Lunghua Town, Baoan Dist., Shenzhen, China.

Tel: 86-755-81789589 Fax: 86-775-81789590

Ningbo Branch Office: Room 2303, Building 1, Homei Garden No.666, Yangmuqi  
Road, Ningbo, Zhejiang, China

Tel/Fax: 86-574-88210669

U.S. Branch Office: 3630 W. Pioneer Pkwy., Suite 127, Arlington,  
TX 76013. U.S.A. Tel: (817)860-7299 Fax: (817)860-7499

Reporter: Monica Bostick

Legal Advisor: Chenyi Law Firm, Chang Lee Chung

Printing: Chuen Fung Enterprise Co., Ltd.

[www.biketaiwan.com](http://www.biketaiwan.com)



Copyright 2015 by Wheel Giant Inc.  
All Rights Reserved. Nothing in this magazine  
may be reprinted in whole or in part,  
by electronic retrieval or any other means,  
without the express permission of the publisher.



# ENRICH YOUR CYCLING LIFE

# STYLISH LIFE

隨性暢快



## SILENCE HUB ITEM NO. DA8347BQ-QR

The ingenious O-ring Nut is designated to protect and improve the bearing motion inside the hub. It's the best design at its category.

**CHOSEN**  
CHOSEN CO., LTD.

[www.chosen-hubs.com](http://www.chosen-hubs.com)

[chosen.twn@msa.hinet.net](mailto:chosen.twn@msa.hinet.net)

TEL +886-4-7588-777

+886-4-7588-889

# KENDA

DESIGNED  
FOR YOUR  
JOURNEY

## HONEY BADGER DH Pro

26x2.40 , 27.5x2.40

**K1127B**

The Honey Badger DH is offered in Kenda's distinctive downhill constructions and the new Light Gravity Casing option that shaves hundreds of grams off the tire making it adept at climbing as well as descending. Downhill, All-Mountain, or Enduro - Honey Badger don't care!

[www.kendatire.com](http://www.kendatire.com)



台灣精品 2015  
TAIWAN EXCELLENCE

Visit us on the web at:  
**KendaTire.com**



KENDA RUBBER IND. CO., LTD.

146, Sec.1 Chung Shan Road Yuanlin, Taiwan,R.O.C. (51064)

Tel : 886-4-834-5171 Fax : 886-4-833-1865

**facebook**

KendaBicycle